

Facsimile

## Quick Reference Guide

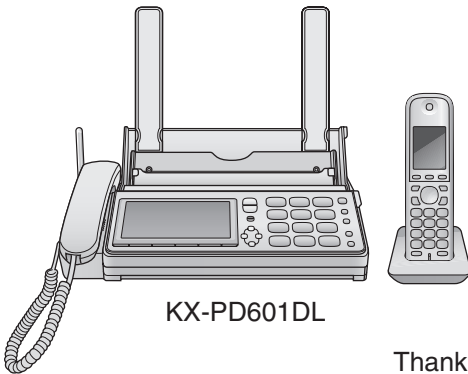

KX-PD601DL

Model No. **KX-PD601DL**  
**KX-PD601DW**

Main unit: KX-PD601  
Portable handset: KX-FKD502

Thank you for purchasing a Panasonic product.

### Table of Contents

Finding the controls .....	2
Inserting the battery into the main unit .....	4
Installations and connections .....	5
Setting your fax telephone number to the main unit .....	8
Setting your logo to the main unit .....	9
Character input and command key table .....	10
Voice guide .....	11
Automatic dialing on the main unit .....	12
Recording a telephone conversation on the main unit .....	13
Automatic dialing on the portable handset (KX-FKD502) .....	14
Intercom .....	16
Sending faxes .....	17
Copying documents .....	17
Receiving faxes .....	18
Operating the built-in answering device .....	21
Night mode .....	23
Call block .....	24
SD Memory Card .....	25
Trademarks .....	26
Making or receiving a call during a power failure (Simplified power failure voice call) .....	27
Specifications .....	Back cover

- This guide explains some basic features and operations, but not all of them. For further details, see the Japanese operating instructions.
- This product is designed for use in Japan.  
Panasonic cannot provide service for this product if used outside Japan.
- KX-PD601DL includes 1 portable handset and 1 main unit.  
KX-PD601DW includes 2 portable handsets and 1 main unit.
- Any details given in this guide are subject to change without notice.

**This unit is equipped with the voice guide features. (Japanese only)**  
**Cancel the voice guide features after installations and connections.**  
**This guide explains the procedures without the voice guide.**  
**For details about voice guide, please see page 11.**

# Finding the controls

## Main unit

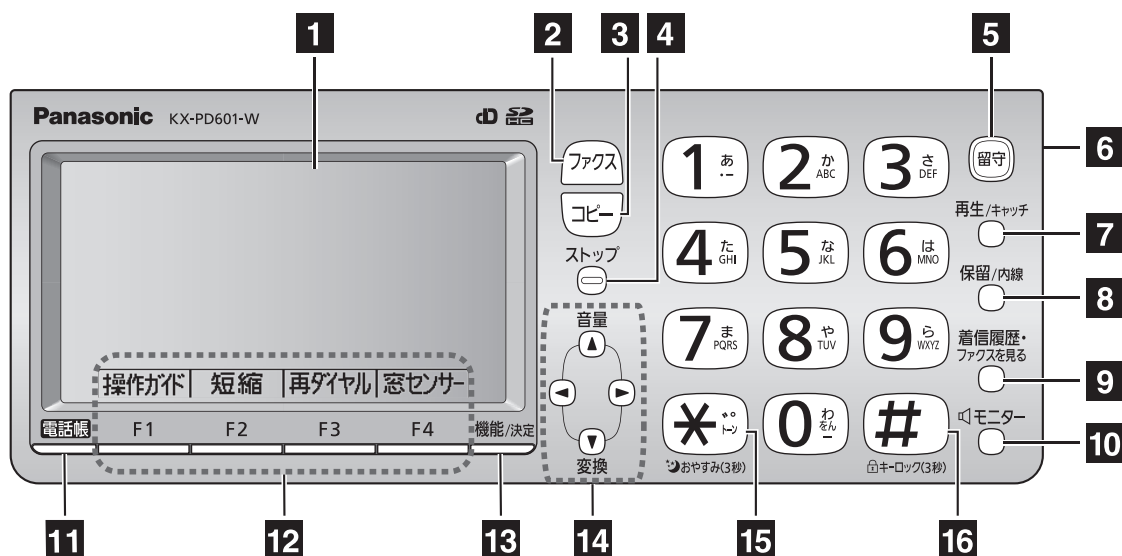

### 1 Liquid crystal display

- The display turns off after about 2 minutes of inactivity.
- To turn on the display, press  (Stop).

### 2 Fax button starts faxing.

### 3 Copy button starts copying.

### 4 Stop button

### 5 Auto Answer button & indicator

- light on: answering device activated.
- light off: used as a regular telephone.

### 6 SD Memory Card slot (See page 25.)

### 7 Playback button plays back recorded messages. Flash button (For call waiting service users.)

### 8 Hold button Intercom button

### 9 Caller ID Log/Fax List button starts a search in

- the Number Display (Caller ID) log.
- the fax list stored in memory.

- Caller ID Log/Fax List indicator lights when**
- a call was missed. (For Number Display service users.)
  - a fax was stored in memory.

### 10 Monitor button

### 11 Phonebook button

### 12 Multi-operation buttons refer to the function displayed on the display panel.

### 13 Function/Set button

- To initiate programming.
- To store a parameter.

### 14 Volume/Change key



- To adjust the volume (see below).
- To change Hiragana into Kanji.

#### ■ To adjust the **ringer volume** when the unit is on stand by

- ▲ (Select “呼出音量設定”) ➡
- 機能/決定 (Function/Set) ➡ ▲ (press repeatedly) ➡
- 機能/決定 (Function/Set) or ストップ (Stop)

#### ■ To adjust the **receiver volume** while talking, press ▲ repeatedly.

#### ■ To adjust the **speaker volume** while listening to the recorded messages or using the monitor, press ▲ repeatedly.

### 15 Tone button switches to tone dialing. Night mode button











### 16 Sharp button

- Key lock** button can lock the main unit so that no calls or settings can be made. To turn key lock on, press this button for about 3 seconds until a single beep is heard.
- To turn key lock off, press this button for about 3 seconds.

# Finding the controls

## Portable handset (KX-FKD502)

### How to use key

-  ● To redial the telephone numbers in the redial list. The last 10 telephone numbers dialed are stored in memory.
-  ● To start a search in the Number Display log. (For Number Display service users.)
-  ● To change Hiragana to Kanji.
- To adjust the volume.
  - To adjust the ringer volume when the portable handset is on standby, press  (Select “呼出音量”) →  →  (press repeatedly) →  or .
  - To adjust the receiver volume while talking, press  repeatedly.
  - To adjust the speaker volume while listening to the recorded messages or using the speakerphone, press  repeatedly.

### スピーカーホン

-  ● To use the speakerphone.

### 内線

-  ● To put a call on hold.
- To page the main unit and/or portable handset(s).



- To make/answer calls.



- To end a call.
- To end or exit from editing or other operations.

Earpiece

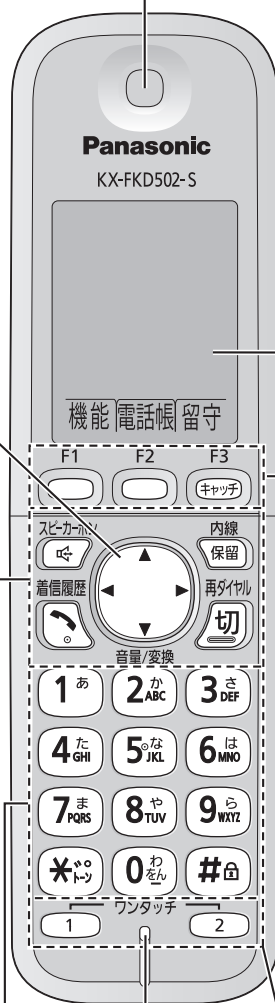



Microphone



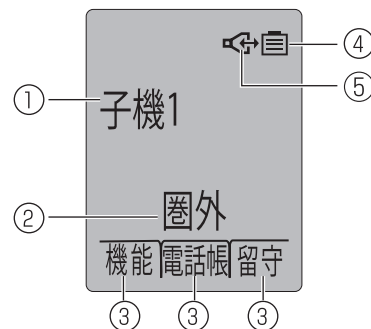

Do not cover the microphone while talking.

Liquid crystal display



- ① ..... Portable handset number and name
- ② ..... No link to the main unit
- ③ ..... Function menu that is controlled by ,  or 
- ④ ..... Battery strength
- ⑤ ..... When using the speakerphone



### How to use , , buttons

- ,  and  buttons refer to the function displayed on the bottom of the display. They function differently depending on the mode.
- To answer a second call on the other call, press . (For call waiting service users.)



- To make a voice call using One-touch dialer.

### Dial buttons

-  Tone button
  - To switch to tone dialing.
-  Sharp button
- Key lock button
  - To lock the portable handset so that no calls or settings can be made. To turn key lock on, press this button for about 3 seconds until a single beep is heard.
  - To turn key lock off, press this button for about 3 seconds until a single beep is heard.

# Inserting the battery into the main unit

By using the battery, you can make or receive calls from the main unit or the portable handset in the event of a power failure. (See “Making or receiving a call during a power failure (Simplified power failure voice call)” on page 27.)

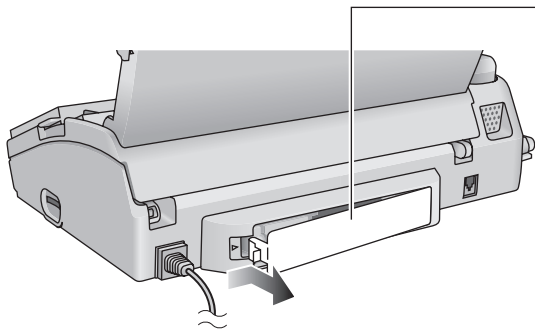

- 1** Open the battery cover.
  - Pull the battery cover toward you while retaining the lever in the direction of the arrow.

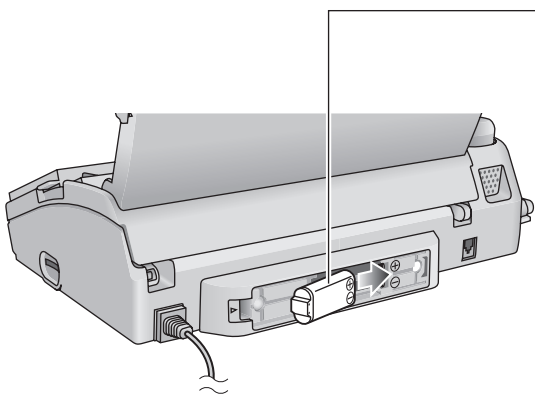

- 2** Insert the battery into the compartment.
  - The battery is the same as the battery in the portable handset.

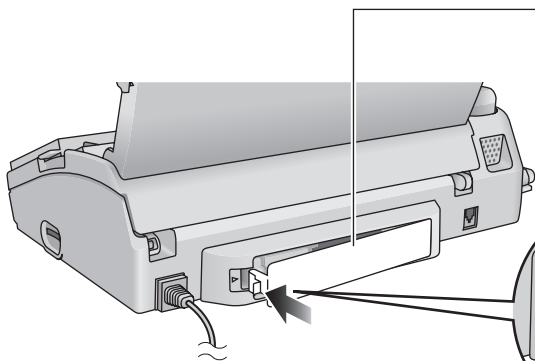

- 3** Close the battery cover.

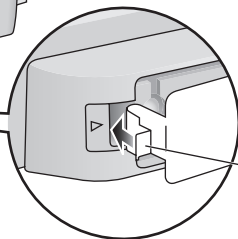

Close the cover by pushing this part in the direction of the arrow.

- The charging time for the battery of the main unit is about 10 hours.

# Installations and connections

## Installing the ink film

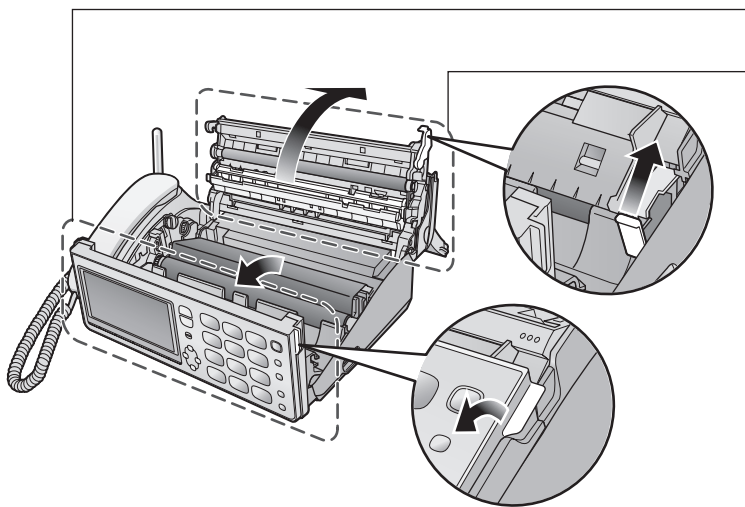

- 1** Open the control panel.
- 2** Pull up the green lever and open the back cover.

Insert the orange gear into the left slot of the main unit.

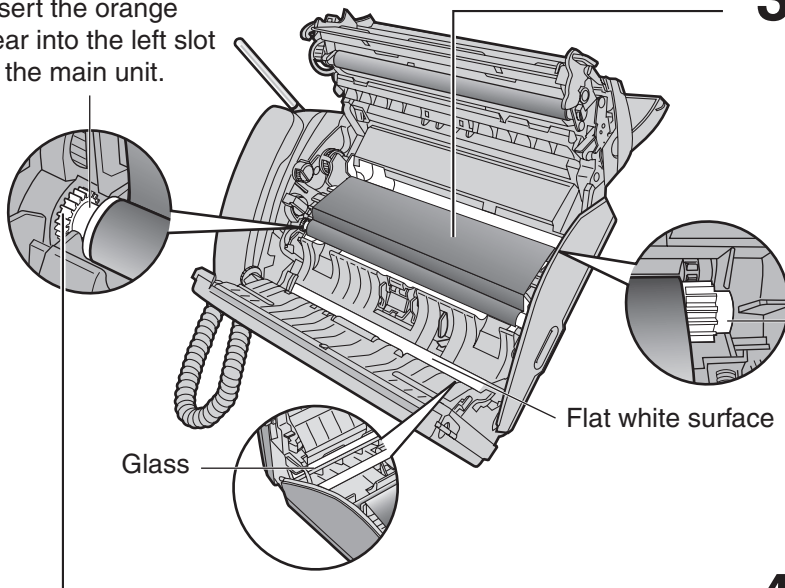

- 3** Insert the ink film.
  - Do not place the ink film on the back side of the control panel. Any ink adhering to the glass or flat white surface may cause black or white lines to appear on the recording paper or the recipient's fax.

Insert the white gear into the right slot of the main unit.

- 4** If the ink film is slack, tighten it by winding this gear (orange).

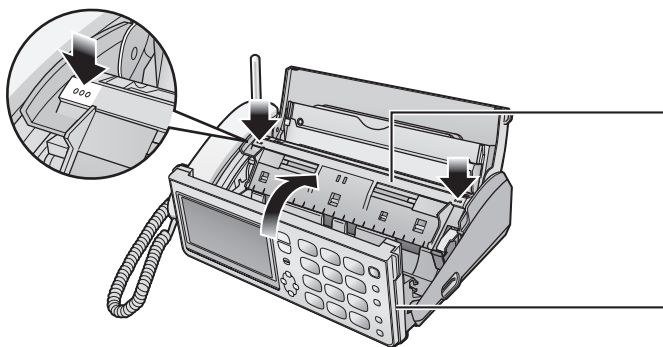

- 5** Close the back cover pressing "○○○" down on both sides until it clicks into place.
- 6** Close the control panel.

• When the unit runs out of the ink film, the following message will be displayed.

インクフィルムの交換が U23  
必要です  
(フィルム品番: KX-FAN190)



販売店にて  
お買い求めください  
(フィルム品番: KX-FAN190)

Install a new ink film.

Replacement ink film:	
<b>KX-FAN190</b> (15 m)	¥ 714
<b>KX-FAN190W</b> (15 m x 2)	¥ 1,208
<b>KX-FAN191</b> (15 m)* <sup>1</sup>	¥ 893
<b>KX-FAN191W</b> (15 m x 2)* <sup>1</sup>	¥ 1,523

\*1 KX-FAN191/KX-FAN191W leaves a fainter print trail on the film than KX-FAN190/KX-FAN190W does.

· As of June 2012

· Tax included

# Installations and connections

## Installing recording paper (A4 size)

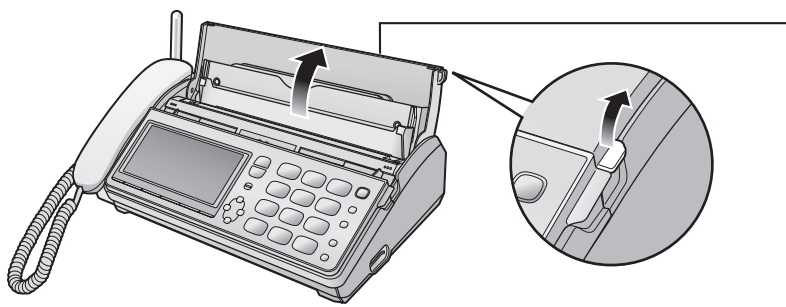

**1** Open the recording paper tray.

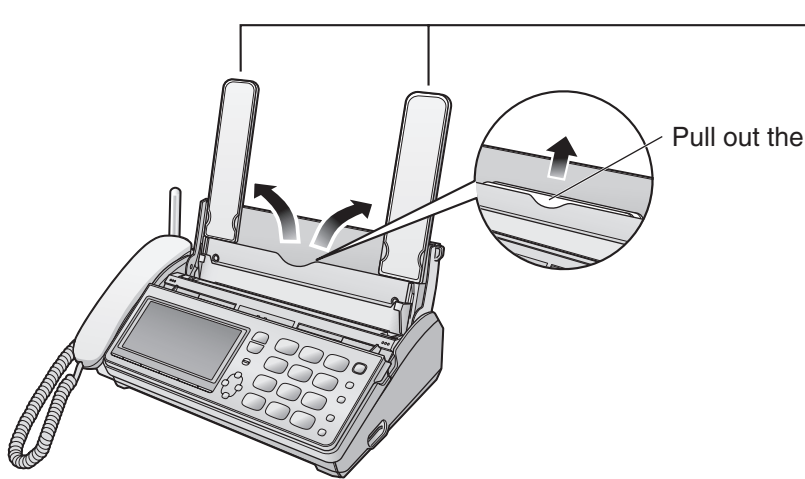

**2** Set up the recording paper stands.

Pull out the front stand first.

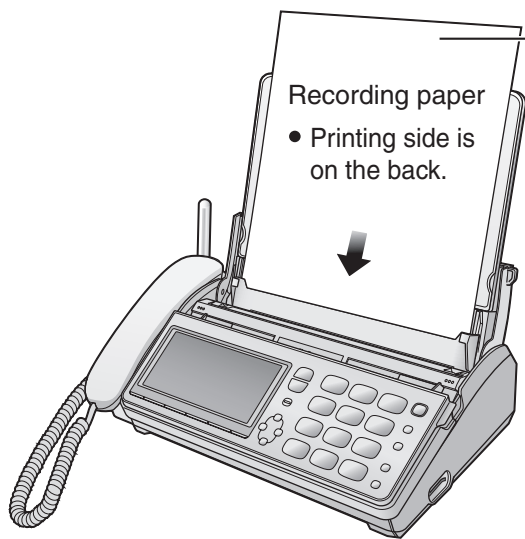

**3** Insert the recording paper into the recording paper tray. (Up to 15 sheets)

- Fan the stack of recording paper.

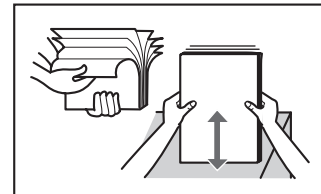

## Folding the recording paper tray

① Remove the recording paper and fold the recording paper stands in.



② Close the recording paper tray.

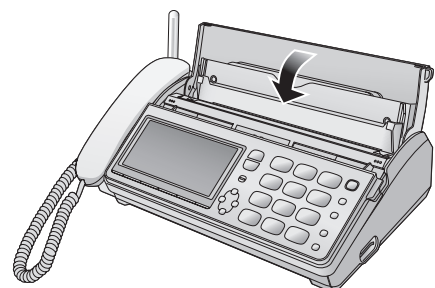

# Installations and connections

## Connecting the main unit

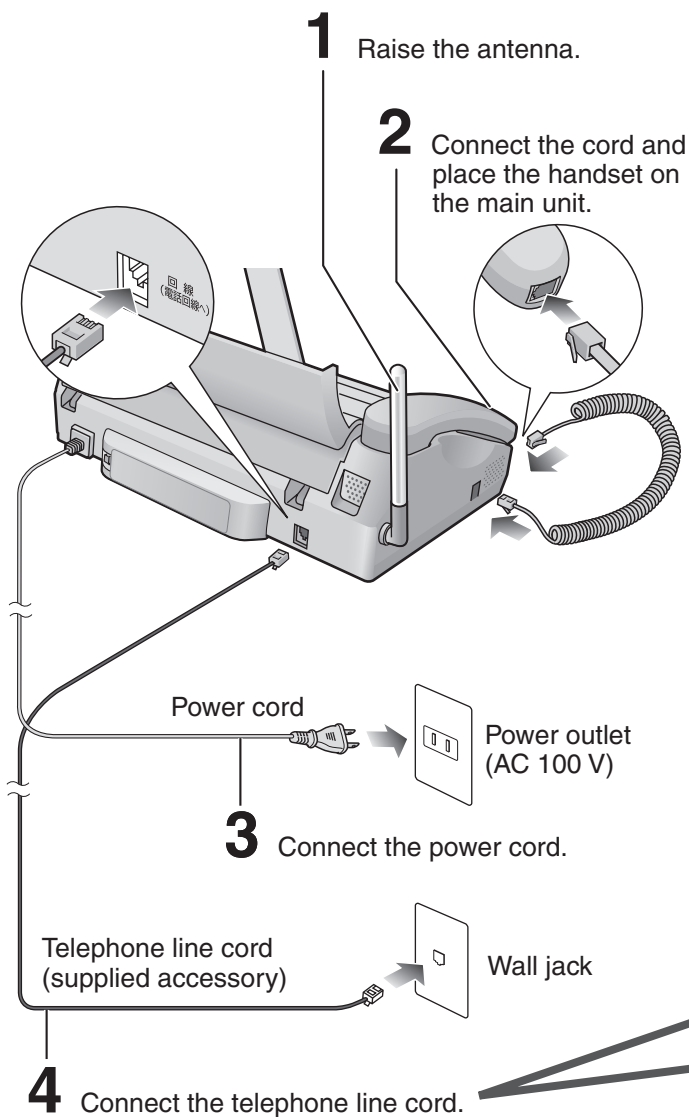

### After the Connecting...

- This unit will automatically select the dialing mode (Pulse/Tone).
- When the following is displayed, press **機能/決定** (Function/Set) to set the date and time.

日付・時刻を  
設定するには  
[機能] 押す

- Enter the correct year/month/day.

**Example: October 1, 2012**

Press **1 2 1 0 0 1**.

日付時刻  
2012年10月01日  
00:00

- Enter the correct hour/minute in a 24-hour clock entry.

**Example: 15:45 (3:45 PM)**

Press **1 5 4 5**.

日付時刻  
2012年10月01日  
15:45

- Press **機能/決定** (Function/Set).

- When the following is displayed, press **ストップ** (Stop) twice.

携帯電話にかけるとき  
電話会社の

通話料金割引サービス  
を利用しますか?

### ↓ If you cannot make a call...

Set the dialing mode with the main unit.

- Press **機能/決定** (Function/Set).
- Press **# 0 7 9**.
- Press **▲ ▼** (Search button) repeatedly until the desired setting is selected, then press **機能/決定** (Function/Set).

回線種別

20  
10

- 自動: Auto (Default)
- フッシュ: Tone
- 20: Pulse (20 PPS)
- 10: Pulse (10 PPS)

- If you have selected “フッシュ”, “20” or “10”, press **ストップ** (Stop).

### ■ To adjust the date and time

- Press **機能/決定** (Function/Set), then press **# 0 0 1**.
- Enter the correct year/month/day/hour/minute.
- Press **機能/決定** (Function/Set), then press **ストップ** (Stop).

# Installations and connections

## Setting up the portable handset (KX-FKD502)

- 1** Press  on the battery cover and slide the cover off.

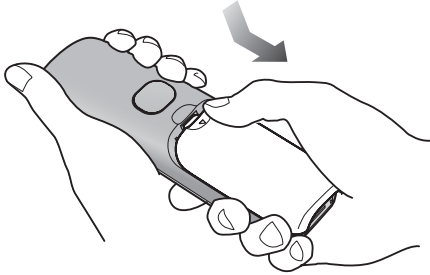

- 2** Insert the battery into the compartment and close the battery cover.

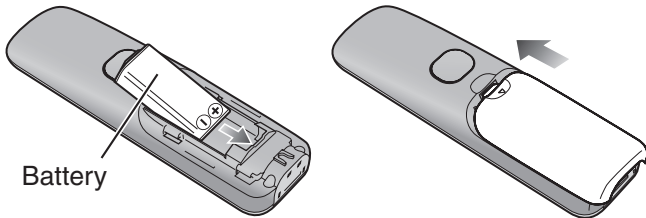

- 3** Connect the charger to the power outlet, then place the portable handset on the charger for about **10 hours**.

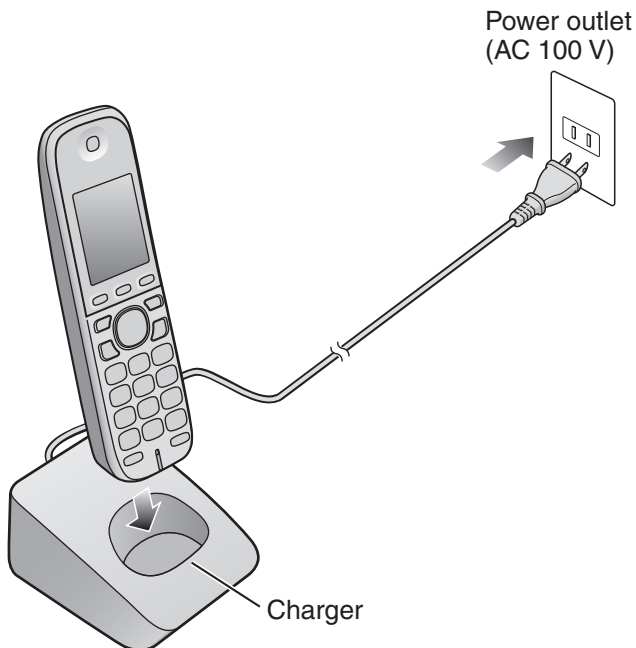

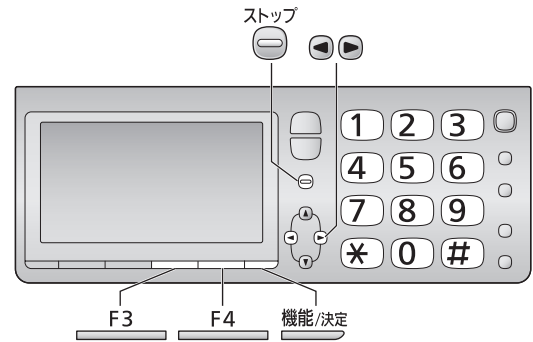

- After your Panasonic battery is fully charged, it will last up to about 5 hours of conversation.

# Setting your fax telephone number to the main unit





- 1** Press  (Function/Set).

- 2** Press    .

- 3** Enter your fax telephone number, up to 20 digits.

**Example: +098 7654..**

あなたの電話番号?  
+098 7654..

- The  (Tone) button replaces the digit with “+”.
- The  (Space) button replaces the digit with a space.
- To correct a mistake, press  (Erase).

- 4** Press  (Function/Set).

登録しました



あなたの電話番号?  
☎098 7654..

- 5** Press  (Stop).



# Setting your logo to the main unit

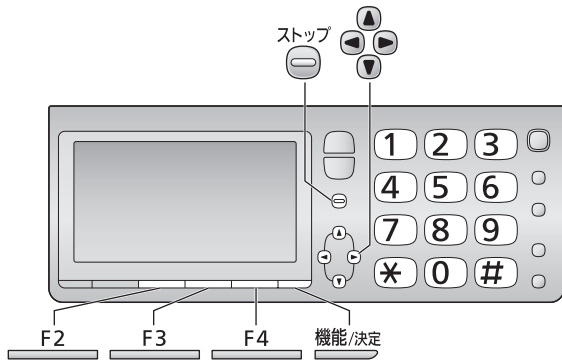

**1** Press **機能/決定** (Function/Set).

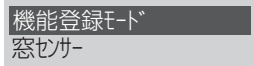

**2** Press **# 0 0 2**.

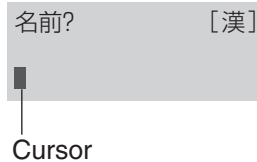

**3** Enter your logo, up to 30 characters, using the dial keypad.

- To enter Alphabets, press **文字切替 F2** (Character input mode) repeatedly and select “英” (Alphabets and sign input mode).
- For details, see the table on page 10 for instructions.

## Example: Micah

**1.** Press **6** once.

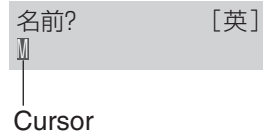

**2.** Press **4** six times.

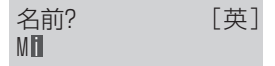

**3.** Press **2** six times.



**4.** Press **▶** (Search button) to move the cursor to the next space and press **2** four times.



**5.** Press **4** five times.



**4** Press **機能/決定** (Function/Set).

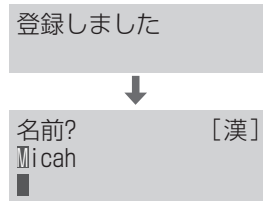

**5** Press **ストップ** (Stop).

# Character input and command key table

Pressing the dial keys will select a character as shown below.





Character		Hiragana	Katakana	Alphabets	Numbers
Display of the main unit and the portable handset		[漢]	[カ]	[英]	[数]
Dial key					
(Main unit) 1 あ	(Portable handset KX-FKD502) 1 あ	あいうえお あいうえお	アイウエオ アイウエオ	@ . _ - & \$ ¥ % + = ~ ^	1
2 か	2 か	かきくけこ	カキクケコ	A B C a b c	2
3 さ	3 さ	さしすせそ	サシスセソ	D E F d e f	3
4 た	4 た	たちつてとっ	タチツテトッ	G H I g h i	4
5 な	5 な	なにぬねの	ナニヌネノ	J K L j k l	5
6 は	6 は	はひふへほ	ハヒフヘホ	M N O m n o	6
7 ま	7 ま	まみむめも	マミムメモ	P Q R S p q r s	7
8 や	8 や	やゆよやゆよ	ヤユヨヤユヨ	T U V t u v	8
9 ろ	9 ろ	らりるれろ	ラリルレロ	W X Y Z w x y z	9
0 わ	0 わ	わをんー	ワヲンー	! ? / - * # . : ;   ' " ( ) [ ] { } < > 「 」	0
* *	* *	ゝ っ っ っ	ゝ っ っ っ	ゝ っ っ っ	
Command keys		文字切替 F2 (Main unit), F1 (Portable handset)	Used to change the character input mode.		
		◀ ▶ (Main unit), ◀ ▶ (Portable handset)	Used to move the cursor to the left and right.		
		消去 F3 (Main unit), F3 キヤッチ (Portable handset)	Used to delete a character. To delete the character on the cursor and one(s) to its right, press this button for 2 seconds or more.		
		スペース F4 (Main unit), 保留 (Portable handset)	Used to insert a space.		

- The characters on the display are somewhat different from those shown in the character input and command key table.

# Voice guide

## Operation guide

The unit starts the following voice guidance in Japanese:

Operations	To cancel the operation guide (using the main unit)
Send a fax	機能/決定 → # 0 2 1 →  (Select “なし”) → 機能/決定 → 
Copy	
Add entries to the phonebook	
Store phonebook entries in the speed dialer	機能/決定 → # 1 6 7 →  (Select “なし”) → 機能/決定 → 
Make a call using the phonebook/redial/ speed dialer/caller ID log	
Change the ink film	The operation guide for changing the ink film cannot be prevented from starting.

## Reading-out dial

The unit announces the dialed number in Japanese.

### • To cancel the reading-out dial

機能/決定 → # 1 3 0 →  (Select “なし”) → 機能/決定 → 

## Reading-out phonebook

The unit reads out stored names\* when the phonebook is searched.

### • To cancel the reading-out phonebook

機能/決定 → # 1 3 2 →  (Select “なし”) → 機能/決定 → 

## Incoming name announcement (for Number Display service subscribers only)

The unit announces the caller's name\* when a call is received from a caller whose name and telephone number are stored in the phonebook.

### • To cancel the incoming name announcement

機能/決定 → # 1 8 2 →  (Select “なし”) → 機能/決定 → 

\* Names will only be read out when their “フリガナ” (readings) are stored in katakana in the phonebook. Alphabets, numbers and symbols in “フリガナ” are not read out.

# Automatic dialing on the main unit

## Storing names and telephone numbers in the phonebook

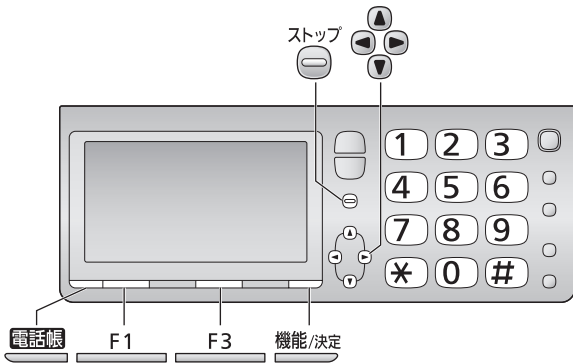

- 1 Press **電話帳** (Phonebook).
- 2 Press **新規登録 F1** (Register).
  - “XXX” shows the number of remaining stations numbers you can store.
  - You can store up to 150 stations, including 4 pre-stored stations.

名前?	[漢]
空き XXX件	
- 3 Enter the name, up to 20 characters (see the table on page 10 for instructions).
- 4 Press **機能/決定** (Function/Set) twice.
- 5 Enter the telephone number, up to 24 digits.
  - To correct a mistake, press **消去 F3** (Erase).
- 6 Press **機能/決定** (Function/Set).
- 7 Press **Search button** repeatedly to select the desired group number.
- 8 Press **機能/決定** (Function/Set).
  - To store other items, repeat steps 3 to 8.
- 9 Press **ストップ** (Stop) to exit.

## Making a voice call using the phonebook

- 1 Press **電話帳** (Phonebook).
- 2 Press **Search button** repeatedly to select “すべてから探す” (Search using the phonebook), then press **機能/決定** (Function/Set).
- 3 Press **Search button** repeatedly to select the desired name.
- 4 Lift the handset.

## Editing a stored name or number in the phonebook

- 1 Press **電話帳** (Phonebook).
- 2 Press **Search button** repeatedly to select “すべてから探す” (Search using the phonebook), then press **機能/決定** (Function/Set).
- 3 Press **Search button** repeatedly to select the desired name.
- 4 Press **修正 F3** (Edit).
- 5 Edit the name (see the table on page 10 for instructions).
  - If you do not need to edit the name, skip to step 6.
- 6 Press **機能/決定** (Function/Set).
- 7 Edit the reading.
  - If you do not need to edit the reading, skip to step 8.
- 8 Press **機能/決定** (Function/Set).
- 9 Edit the telephone number.
  - If you do not need to edit the telephone number, skip to step 10.
- 10 Press **機能/決定** (Function/Set).
- 11 Press **Search button** repeatedly to select the group number.
  - If you do not need to change the group number, skip to step 12.
- 12 Press **機能/決定** (Function/Set).
- 13 Press **ストップ** (Stop).

# Automatic dialing on the main unit

## Storing names and telephone numbers in the speed dialer

You can store up to 9 names and telephone numbers which are stored in the phonebook. The dialing buttons (1) to (9) function as memory stations.

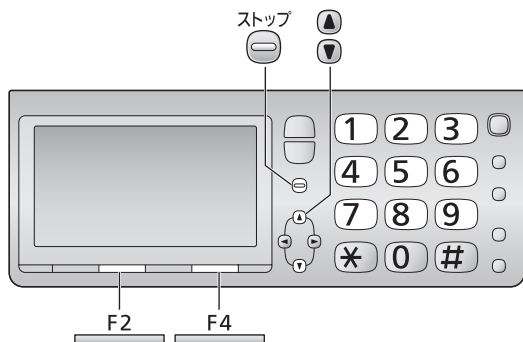

- 1 Press **短縮 F2** (Speed dialer).
- 2 Press **↑ ↓** (Search button) repeatedly to select the desired memory station number.
  - You can also select the memory station number by pressing the dialing buttons (1) to (9).

Example: Speed dialer 1

1. (未登録)  
Memory station number

- 3 Press **新規登録 F4** (Register).
- 4 Press **↑ ↓** (Search button) repeatedly to select the desired name.
- 5 Press **登録 F4** (Set).
  - To store other items, repeat steps 2 to 5.
- 6 Press **ストップ** (Stop) to exit.

## Making a voice call using the speed dialer

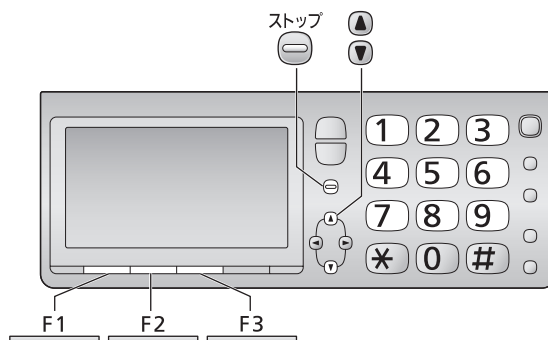

- 1 Press **短縮 F2** (Speed dialer).
- 2 Press **↑ ↓** (Search button) repeatedly to select the desired memory station number.
  - You can also select the memory station number by pressing the dialing buttons (1) to (9).
- 3 Lift the handset.

## Erasing a stored name and number in the speed dialer

- 1 Press **短縮 F2** (Speed dialer).
- 2 Press **↑ ↓** (Search button) repeatedly to select the desired memory station number.
  - You can also select the memory station number by pressing the dialing buttons (1) to (9).
- 3 Press **消去 F3** (Erase), then press **はい F1** (Yes).
- 4 Press **ストップ** (Stop) to exit.

# Recording a telephone conversation on the main unit

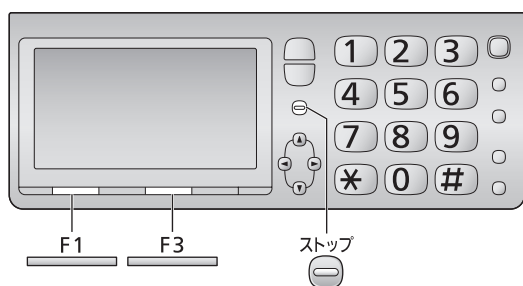

- 1 While talking, press **通話録音 F1** (Record) then press **通話録音 F3** (Record the voice).
- 2 Press **いいえ F3** (Cancel the precaution voice message) and the recording starts.
- 3 Press **ストップ** (Stop) to end the recording.

# Automatic dialing on the portable handset (KX-FKD502)

## Storing names and telephone numbers in the phonebook

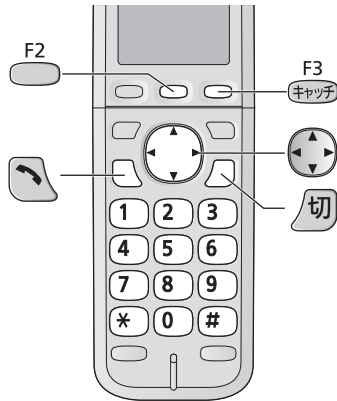

**1** Press F2.

検索は  
[▼,▲]押す

**2** Press F2.

- “XXX” shows the number of remaining stations you can store.
- You can store up to 150 stations, including 4 pre-stored stations.

名前?  
空き XXX件

**3** Enter the name, up to 20 characters (see the table on page 10 for instructions).

**4** Press F2 twice.

**5** Enter the telephone number, up to 24 digits.

- To correct a mistake, press F3 (キヤッチ).

**6** Press F2.

**7** Press (Search button) to select a group.

**8** Press F2.

- To store other items, repeat steps 3 to 8.

**9** Press (Off) to exit.

## Making a voice call using the phonebook

**1** Press F2.

**2** Press (Search button) repeatedly until “一覧で探す” is displayed.

**3** Press F2.

**4** Press (Search button) repeatedly until the desired name is displayed.

**5** Press (Talk).

## Editing a stored name or number in the phonebook

**1** Press F2.

**2** Press (Search button) repeatedly until “一覧で探す” is displayed.

**3** Press F2.

**4** Press (Search button) repeatedly until the desired name is displayed.

**5** Press F2.

**6** Edit the name (see the table on page 10 for instructions).

- If you do not need to edit the name, skip to step 7.

**7** Press F2.

**8** Edit the reading.

- If you do not need to edit the reading, skip to step 9.

**9** Press F2.

**10** Enter the correct telephone number.

- If you do not need to edit the telephone number, skip to step 11.

**11** Press F2.

**12** Press (Search button) to select a group.

**13** Press F2.

**14** Press (Off) to exit.

# Automatic dialing on the portable handset (KX-FKD502)

## Storing names and telephone numbers in the one-touch dialer

You can store up to 2 phonebook entries as the one-touch dialer.

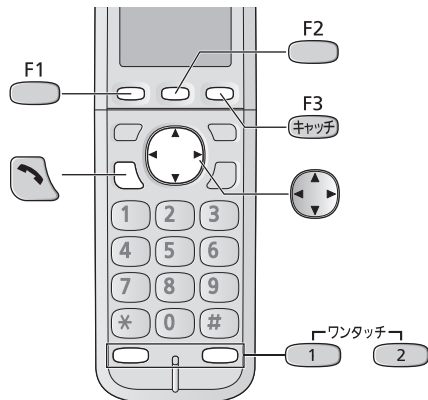

**1** Press **F1**.

**2** Press the one-touch dial button ( **1** or **2** ).

**Example: One-touch dial button 1**

1. 未登録

登録は [登録]  
押す

**3** Press **F2**.

**4** Press **(Search button)** to select the desired name from the phonebook.

- To check the registered items in the phonebook entry, press **F1** → **(Search button)** repeatedly to view the name/telephone number/group. (To exit, press **F1**.)

**5** Press **F2**.

## Making a voice call using the one-touch dialer

**1** Press **(Call button)**.

**2** Press the one-touch dial button ( **1** or **2** ).

- You can also make a call by pressing the one-touch dial button first.

## Erasing a stored name and number in the one-touch dialer

**1** Press **F1**.

**2** Press the one-touch dial button ( **1** or **2** ).

- To check the telephone number, press **F1**.

**3** Press **F3** (**キャッチ**).

**4** Press **F1**.

# Intercom

An intercom is available between the portable handsets or between the main unit and portable handset(s).

## Using the main unit:

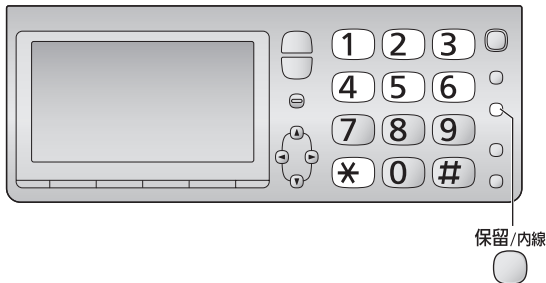

### 1 ■ For single portable handset users

- ① Press  (Hold/Intercom).

子機1

- ② Lift the handset.

### ■ For multiple portable handsets users

- ① Press  (Hold/Intercom).
- ② Call the portable handsets in the following ways:
  - To call a specific portable handset, press the portable handset number (**1** to **6**) which you want to call.
  - To call all the portable handsets, press **\***.
- ③ Lift the handset.

### 2 Start talking.

内線通話中

### 3 To end the intercom call, place the handset on the main unit.

## Using the portable handset (KX-FKD502):

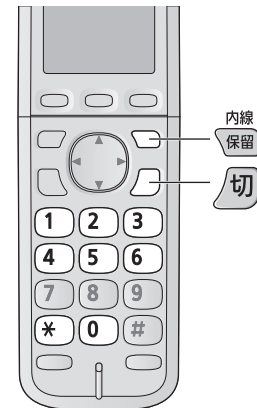

### 1 ■ For single portable handset users

- Press  (Intercom).

### ■ For multiple portable handsets users

- ① Press  (Intercom).
- ② Call the main unit and/or portable handset(s) in the following ways:
  - To call a specific portable handset, press the portable handset number (**1** to **6**) which you want to call.
  - To call the main unit, press **0**.
  - To call the main unit and all the portable handsets, press **\***.

### 2 Start talking.

内線通話中

### 3 Press (Off) to end the intercom call.



# Sending faxes

Cancel the voice guide features before sending a fax. (See page 11)

## Sending a fax manually

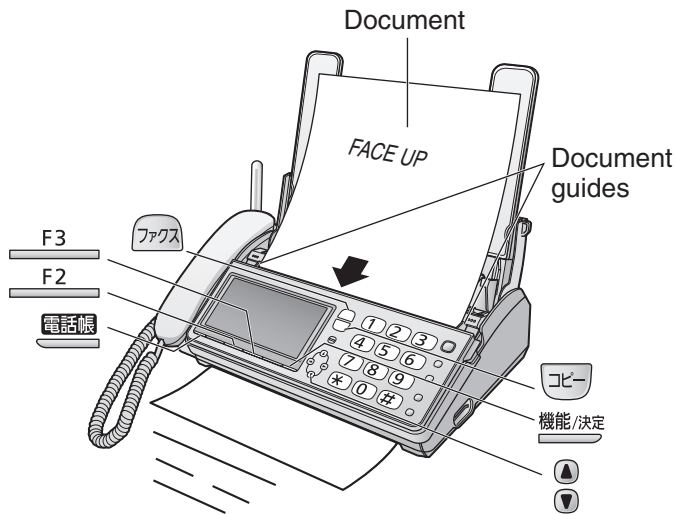

- 1 Open the recording paper tray, and adjust the width of the document guides (blue) to the size of the document.
- 2 Insert the document (up to 5 pages) FACE UP until a single beep is heard.
- 3 If necessary, press  (Resolution) repeatedly to select the desired resolution (see below).
- 4 Dial the fax number.
- 5 Press  (Fax).
  - The unit will start fax transmission.

## Sending a fax using automatic dialing

### Using the phonebook

- 1 Insert the document (up to 5 pages) FACE UP until a single beep is heard.
- 2 Press  (Phonebook).
- 3 Press  (Search button) repeatedly to select “すべてから探す” (Search using the phonebook), then press  (Function/Set).
- 4 Press  (Search button) repeatedly to select the desired name.
- 5 Press  (Fax).
  - The unit will start fax transmission.

### Using the speed dialer

- 1 Insert the document (up to 5 pages) FACE UP until a single beep is heard.
- 2 Press  (Speed dialer).
- 3 Press  (Search button) repeatedly to select the desired memory station number.
  - You can also select the memory station number by pressing the dialing buttons (1) to (9).
- 4 Press  (Fax).
  - The unit will start fax transmission.

### To select the resolution

Select the desired resolution according to the type of document, by pressing  (Resolution) repeatedly.

(Standard) for printed or typewritten originals with normal-sized characters.

(Fine) for originals with minute printing.

(Photo) for originals containing photographs.

# Copying documents

Cancel the voice guide features before copying a document. (See page 11)

- 1 Install the recording paper (see page 6).
- 2 Insert the document (up to 5 pages) FACE UP until a single beep is heard.
  - If necessary, press  (Resolution) repeatedly to select the desired resolution (see above).
- 3 Press  (Copy).
  - The unit will start copying.



# Receiving faxes

You can select beforehand whether to receive faxes by “Receive in memory” or “Receive on recording paper”.

**Receive in memory** : The received fax will be stored in the main unit fax memory or the SD Memory Card. You can check the contents on the display, then print them if necessary.  
(Default setting)

**Receive on recording paper** : The received fax will be printed on recording paper.

## Setting/canceling “Receive in memory”

Press  (Function/Set),  (Receive in memory), then  (Yes).  
(Changes each time they are pressed.)



 : Receive in memory

**Blank**: Receive on recording paper

## Receiving a fax manually (AUTO ANSWER off)

Using the main unit:

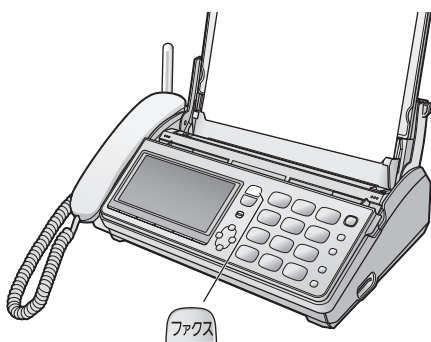



**1** When you hear a ring, lift the handset to answer the call.

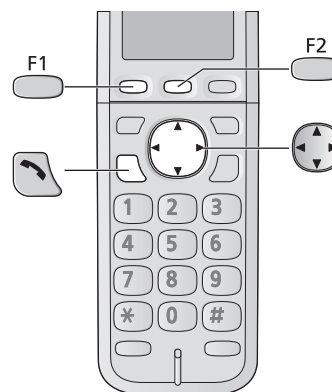

**2** When:  
– document reception is required,  
– a fax calling tone (slow beep) is heard, or  
– no sound is heard,  
press  (Fax), then place the handset on the main unit.  
• The unit will start fax reception.

Using the portable handset (KX-FKD502):



**1** When you hear a ring, lift the portable handset from the charger, then press  (Talk) to answer the call.

**2** When:  
– document reception is required,  
– a fax calling tone (slow beep) is heard, or  
– no sound is heard,  
press .



**3** Press  (Search button) repeatedly until the “ファクス受信” is displayed, then press .

**4** Press .

- The main unit will start fax reception.

## Receiving a fax automatically (AUTO ANSWER on)



**1** If the  (Auto answer) light is off, turn it on by pressing .

**2** When receiving a call, the unit will receive a fax document or record a voice message automatically depending on the caller’s request.

# Receiving faxes

## Display when faxes are received in memory

When new faxes are received in memory,  (Caller ID Log/Fax list) will light on.

- It will also light on when a call is missed. (For Number Display service users.)
- If an SD Memory Card is inserted, new faxes will be received in the SD Memory Card. (To view the faxes in the SD Memory Card, see page 26.)

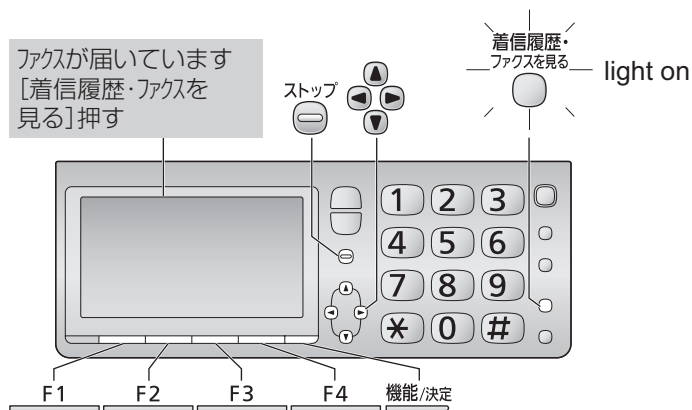

## Viewing faxes stored in memory

You can view faxes stored in memory even during a voice call.

- 1 Press  (Caller ID Log/Fax list).
- 2 Press  (Search button) to select “本体ファクス” (fax list in the main unit memory), then press  (Function/Set).
- 3 Press  (Search button) to select a fax to display.



- You can view a detailed fax list by pressing  (Function/Set).  
means this message has not been saved to any SD Memory Cards

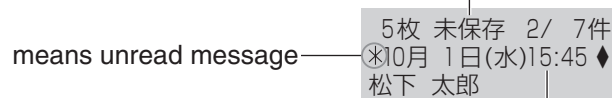

Wednesday, October 1st, 15:45



- 4 Press  (Display) to view the fax (see below for details).

- To print the displayed page,

press  (Print),



 (Search button) to select “このページを印刷” (Print this page), then press  (Function/Set).

- 5 To view other faxes, press  (More buttons) repeatedly until  (Return) is displayed, then press  (Return) and repeat steps 3 to 5.

- 6 Press  (Stop) to exit.

### Information about display

#### ■ To scroll display contents

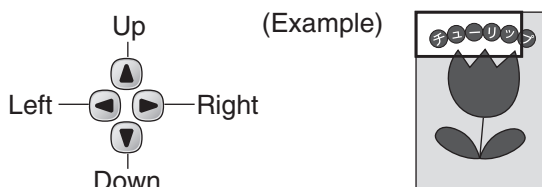

The display contents can be scrolled up, down, left and right.

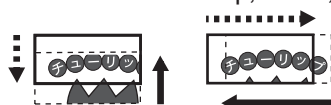





#### ■ Scroll pages

To show the next page: Press  (Next page).



To show the previous page: Press  (Previous page).

#### ■ To enlarge or reduce content

To enlarge the display content: Press  (More buttons),  (Enlarge).

To reduce the display content: Press  (More buttons),  (Reduce).

#### ■ To turn display contents

Press  (More buttons),  (Turn).

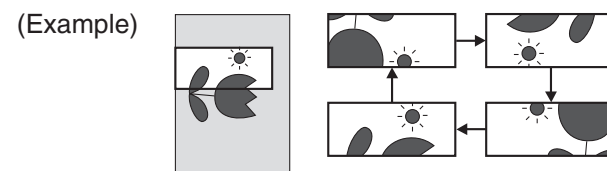

# Receiving faxes

## Printing a specific fax stored in memory

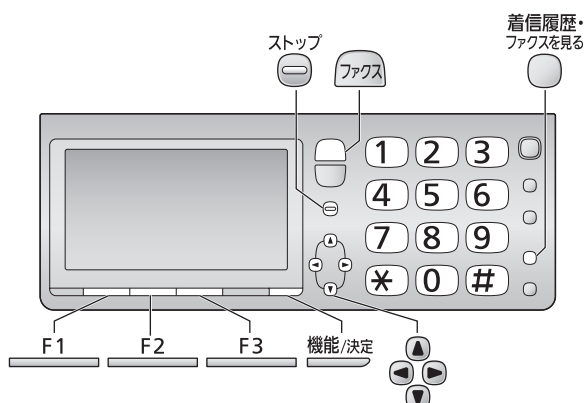

- 1 Press (Caller ID Log/Fax list).
- 2 Press (Search button) to select “本体ファクス” (fax list in the main unit memory), then press (Function/Set).
- 3 Press (Search button) to select the desired fax to print, then press (Print).
- 4 After printing, the following is displayed.
 

Do you delete the printed contents? 印刷した内容を消去しますか?

  - If you want to delete the fax, press (Yes).
  - If you want to save the fax, press (No).
- 5 Press (Stop).

## Deleting a specific fax stored in memory

- 1 Press (Caller ID Log/Fax list).
- 2 Press (Search button) to select “本体ファクス” (fax list in the main unit memory), then press (Function/Set).
- 3 Press (Search button) to select the desired fax to delete.
- 4 Press (More buttons), (More buttons), (Erase).

Do you delete the fax? 消去しますか?

or

Do you delete the new fax? 消去しますか?  
このファクスは未読です

- 5 If you want to delete the fax, press (Yes).
  - If you want to save the fax, press (No).
- 6 If you want to delete other faxes, repeat steps 3 to 5.
- 7 Press (Stop).

## Forwarding received faxes stored in memory

- 1 Press (Caller ID Log/Fax list).
- 2 Press (Search button) to select “本体ファクス” (fax list in the main unit memory), then press (Function/Set).
- 3 Press (Search button) to select a fax.
- 4 Press (More buttons), (More buttons).
- 5 Press (Forward a fax), (Forward a fax).
- 6 Dial the fax number.
- 7 Press (Fax).
  - The unit will start fax transmission.

# Operating the built-in answering device

## Recording your own greeting message

You can record your own greeting message. When receiving a call, it will be played to callers instead of the pre-recorded Japanese greeting message.

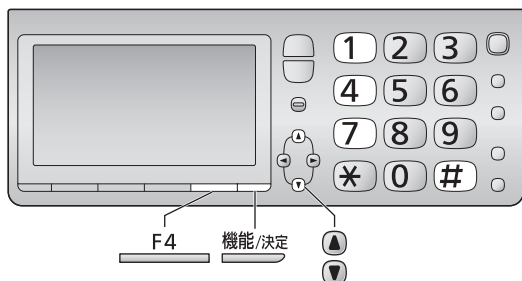

- 1 Press 機能/決定 (Function/Set).
- 2 Press # 1 4 7.
- 3 Press ▲ ▼ (Search button) to select the message number to record to, then press 機能/決定 (Function/Set).
  - You can record different greeting messages to “自作1” and “自作2”.

受話器を取ってください

- 4 Lift the handset.
- 5 Press 開始 F4 (Start) and speak your greeting message after a beep, up to 20 seconds, to the handset.
- 6 Press 終了 F4 (End) and place the handset on the main unit.
  - Your greeting message will be played back automatically.

## Erasing your own greeting message

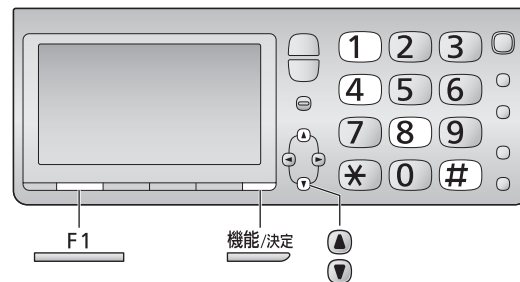



- 1 Press 機能/決定 (Function/Set).
- 2 Press # 1 4 8.
- 3 Press ▲ ▼ (Search button) to select the message number to erase, then press 機能/決定 (Function/Set).

消去しますか?
- 4 Press はい F1 (Yes).

# Operating the built-in answering device

## Activating the answering device

If an SD Memory Card is available (inserted), voice messages will be recorded to the SD Memory Card. (See page 25.)

- 1 Turn the  (Auto answer) light on by pressing .

  - The greeting message will be played back. To change the greeting message, press  repeatedly while playing back the greeting message.
  - To record your own greeting message, see page 21.

- 2 When receiving a call, a greeting message will be played and the unit will record a voice message.

## Listening to recorded messages

When new messages are recorded, the  (Auto answer) light will flash.

Press  to listen to recorded messages.

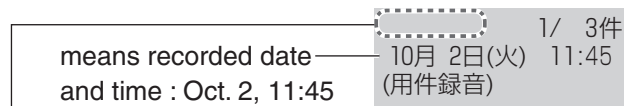



If an SD Memory Card is inserted, the following variations may occur:

- SD : Playing a message in the SD Memory Card.
- 未保存 : Playing a message in the main unit that is not saved to any SD Memory Card.
- Blank : Playing a message in the main unit that has been saved to an SD Memory Card.

After the messages are played back, the following will be displayed.

再生した用件を  
消去しますか?



- To erase the messages, press  (Yes).
- To save the messages, press  (No).

## Listening to the newly recorded messages



Press  (Playback /Flash) when new messages are recorded.

After the messages are played back, the following will be displayed.

再生した用件を  
消去しますか?



- To erase the messages, press  (Yes).
- To save the messages, press  (No).

## Listening to all of the recorded messages



- 1 Press  (Playback /Flash).
- 2 Press  (Search button) to select “すべて再生” (playback all), then press  (Function/Set).

After the messages are played back, the following will be displayed.















すべて消去しますか?

- To erase the messages, press  (Yes).
- To save the messages, press  (No).

## Erasing a specific message

Press  (More buttons),  (Erase) while listening to the message you want to erase, then press  (Yes).

## Erasing all of the recorded messages

- 1 Press  (Function/Set).
  - 2 Press    .
- When not using an SD Memory Card, press  (Yes).
  - When using an SD Memory Card, delete messages as follows:
    - To erase the main unit memory messages, press  (Search button) repeatedly to select “本体メモリ-” (Main unit), then press  (Function/Set),  (Yes).
    - To erase the main unit memory messages and the SD Memory Card messages, press  (Search button) repeatedly to select “本体メモリ+SDカード” (Main unit+SD card), then press  (Function/Set),  (Yes).
    - To erase the SD Memory Card messages, press  (Search button) repeatedly to select “SDカード” (SD card), then press  (Function/Set),  (Yes).

## Operating the built-in answering device

### Operating the answering device from a remote location

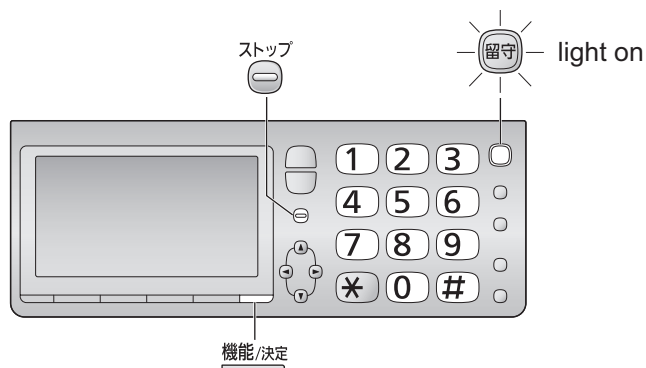

#### Preparation: Setting the remote operation ID

1. Press **機能/決定** (Function/Set).
2. Press **# 0 0 6**.
3. Enter any 4-digit number (remote operation ID) except \* and #.

**Example :** 留守電暗証番号  
1234

4. Press **機能/決定** (Function/Set).
5. Press **ストップ** (Stop).

#### Operation: Listening to a recorded message from a remote location

Turn the **留守** (Auto answer) light on before you go out. Remote operations are available only from a touch tone telephone.

1. Call your unit.
2. Enter the remote operation ID while the greeting message is heard.
3. Press **4** or wait 4 seconds.
  - Only the new recorded messages will be played back.
  - To listen to all the recorded messages, press **5** after the new messages have been played back.

## Night mode

### Turn on the night mode

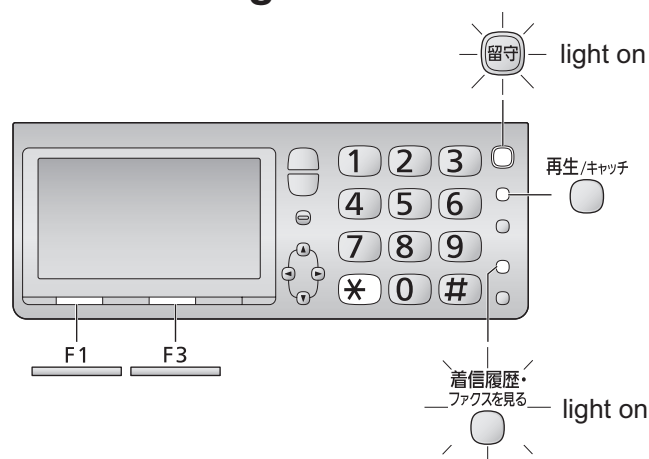

Press **\* (Night mode)** for about 3 seconds.

- **留守** lights on.
- When a call is received during night mode, the unit will handle the call silently, either by storing the received fax into memory or by recording the caller's message.
- Night mode allows you to select a block of time during which the unit will not ring for outside calls or make sounds when you change the settings. This feature is useful when you do not want to be disturbed, for example, while sleeping.

### Listening to recorded messages

When new messages are recorded, the following will be displayed.

新しい用件が  
録音されました

Press **再生/キャッチ** (Playback /Flash) to listen to recorded messages.

After the messages are played back, the following will be displayed.

再生した用件を  
消去しますか？

- To erase the messages, press **F1** (Yes).
- To save the messages, press **F3** (No).

### Printing received fax documents

When new faxes are received, the **着信履歴・ファクスを見る** (Caller ID Log/Fax list) light will turn on.

To print the faxes, see "Printing a specific fax stored in memory" on page 20.

To print the faxes in the SD Memory Card, see page 26.

### Turn off the night mode

Press **\* (Night mode)** for about 3 seconds.

# Call block

## Blocking the incoming calls

Using the main unit:

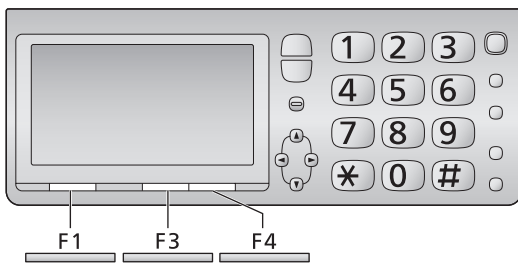

### To block a call using a message

While the unit is ringing, press <sup>通話拒否</sup> F3 (Block).

OR

While you are on an incoming call, press <sup>通話拒否</sup> F3 (Block),  
then press <sup>音声</sup> F1 (Voice).

- The unit announces a message to the caller twice, then hangs up automatically. The message is announced in Japanese and means “We’re sorry, but your call cannot be connected.”

### To block a call using chimes

**1** While you are on an incoming call, press <sup>通話拒否</sup> F3 (Block).

**2** Press <sup>チャイム</sup> F4 (Chime).

- Chime is heard by the caller.

**3** Explain to the caller that a visitor came and hang up.

Using the portable handset (KX-FKD502):

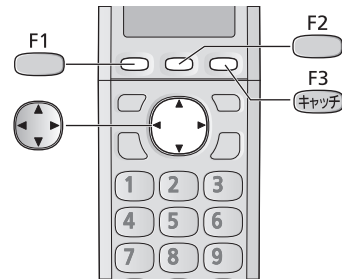

### To block a call using a message

While the unit is ringing, press F1 twice.

OR

While you are on an incoming call,

**1** Press F1.

**2** Press 検索 (Search button) repeatedly until “通話拒否” is displayed.

**3** Press F2.

**4** Press 検索 (Search button) repeatedly until “音声” is displayed.

**5** Press F2.

- The unit announces a message to the caller twice, then hangs up automatically. The message is announced in Japanese and means “We’re sorry, but your call cannot be connected.”

### To block a call using chimes

**1** While you are on an incoming call, press F1.

**2** Press 検索 (Search button) repeatedly until “通話拒否” is displayed, then press F2.

**3** Press 検索 (Search button) repeatedly until “チャイム” is displayed, then press F2.

**4** Explain to the caller that a visitor came and hang up.

## For Number Display service subscribers

- If you subscribe to Number Display service, the message heard by the caller will change according to the caller’s situation.  
**Example:** If the caller requested not to send caller’s information, the message heard by the caller will change to mean “Your telephone number is blocked by service provider. Please call again with adding ‘186’ to the beginning of the telephone number.”
- When the following is displayed after blocking an incoming call, you can set the unit to block the call from the same telephone number.

Using the main unit:

■ To block the call, press <sup>はい</sup> F1 (Yes). 迷惑設定しますか？

■ To cancel blocking, press <sup>いいえ</sup> F3 (No).

• When the following is displayed, 拒否設定しますか？  
press <sup>いいえ</sup> F3 (No) to cancel.

Using the portable handset:

■ To block the call, press F1.

■ To cancel blocking, press <sup>F3</sup> キヤッチ.

• When the following is displayed, 拒否設定しますか？  
press <sup>F3</sup> キヤッチ to cancel.



# SD Memory Card

## Compatible SD Memory Card

- SD Memory Card (2 GB or less)
- SDHC Memory Card (32 GB or less)

## SD indicator

- The SD indicator appears on the display if an SD Memory Card has been inserted.
- The SD indicator flashes while reading or writing to the SD Memory Card.

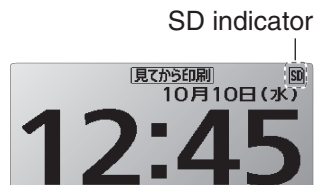

- Never remove the card while the indicator is flashing.

## Inserting the SD Memory Card

Insert the SD Memory Card in the direction of the arrow.

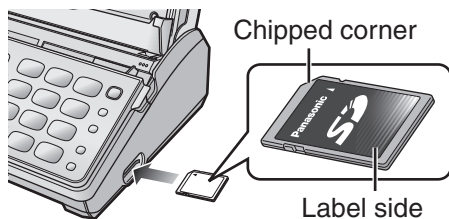

## Removing the SD Memory Card

While the SD indicator is lit (not flashing), push the SD Memory Card in the direction of the arrow, then pull it out.

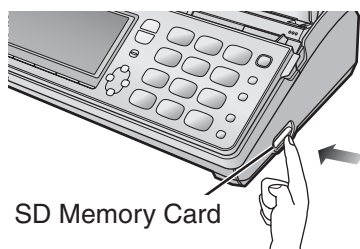

## Saving unsaved voice messages to the SD Memory Card

- 1 Press 機能/決定 (Function/Set).
- 2 Press SDカード  
F2 (SD Card).
- 3 Press  (Search button) repeatedly until the following is displayed.

未保存用件をSD保存  
未保存ファクスをSD保存  
原稿をSD保存

- 4 Press 機能/決定 (Function/Set).
- 5 Press はい  
F1 (Yes).

## Listening to voice messages in the SD Memory Card

See “Listening to the newly recorded messages” and “Listening to all of the recorded messages” on page 22.

## Deleting voice messages from the SD Memory Card

See “Erasing a specific message” and “Erasing all of the recorded messages” on page 22.

## Saving unsaved faxes to the SD Memory Card



- 1 Press 機能/決定 (Function/Set).
- 2 Press SDカード  
F2 (SD Card).
- 3 Press  (Search button) repeatedly until the following is displayed.

未保存用件をSD保存  
未保存ファクスをSD保存  
原稿をSD保存

- 4 Press 機能/決定 (Function/Set).
- 5 Press はい  
F1 (Yes).
- 6 When the SD indicator stops flashing and remains on, press ストップ  
⊖ (Stop).



# SD Memory Card

## Viewing/Printing faxes in the SD Memory Card



- 1 Press  (Caller ID Log/Fax list).
- 2 Press  (Search button) repeatedly until the following is displayed.

着信	:新規	3件
本体ファクス	:未読	2件
SDファクス	:未読	2件
- 3 Press  (Function/Set).



October 9th (Date or time of reception)



*11:04	鈴木 太郎
*10:23	松下 太郎
-10/ 9	092123456
- 4 Press  (Search button) to select a fax to view/print.
- 5 ■ To view the fax, press  (Display).  
■ To print the fax, press  (Print).



After printing:

  - If you want to delete the fax, press  (Yes).
  - If you want to save the fax, press  (No).

## Deleting faxes from the SD Memory Card

- 1 Press  (Caller ID Log/Fax list).
- 2 Press  (Search button) repeatedly until the following is displayed.

着信	:新規	3件
本体ファクス	:未読	2件
SDファクス	:未読	2件
- 3 Press  (Function/Set).
- 4 Press  (Search button) to select the desired fax to delete.



- 5 Press  (More buttons),  (Erase).
- 6 Press  (Yes).



## Displaying documents/Listening voice messages on a PC

- OS environment
  - Microsoft® Windows® 98 operating system
  - Microsoft® Windows® Millennium Edition operating system
  - Microsoft® Windows® 2000 operating system
  - Microsoft® Windows® XP operating system
  - Microsoft® Windows Vista® operating system
  - Microsoft® Windows® 7 operating system
- Image file : (TIFF format)  
Folder : \PRIVATE\MEIGROUP\PCC\FAX\DOC
- Audio file : (WAVE format : It can be played using Windows Media® Player or QuickTime.)  
Folder : \PRIVATE\MEIGROUP\PCC\FAX\REC

## Formatting SD Memory Card

To use an SD Memory Card formatted on a PC or other device, format it as follows. Formatting the SD Memory Card deletes all stored data; this data cannot be recovered.

- 1 Press  (Function/Set).
- 2 Press  (SD Card).
- 3 Press  (Search button) repeatedly until the following is displayed.

SDを整理する
SDをフォーマットする
- 4 Press  (Function/Set).
- 5 Press  (Yes).

## Trademarks

- Microsoft, Windows, Windows Vista and Windows Media are either registered trademarks or trademarks of Microsoft Corporation in the United States and/or other countries.
- QuickTime is a trademark of Apple Computer, Inc., registered in the U.S. and other countries.
- All other trademarks identified herein are the property of their respective owners.

# Making or receiving a call during a power failure (Simplified power failure voice call)

In the event of a power failure, you can make or receive calls from the main unit or the portable handset by using the battery in the main unit.

- You cannot use other functions such as fax, copy or answering device.
- When you first purchase this product, you can make or receive calls only from the main unit. If you wish to make or receive calls from the portable handset as well, it is necessary to make settings (see below).
- To make provision for a power failure, be sure to insert the battery in the main unit. (See “Inserting the battery into the main unit” on page 4.)  
When you insert the battery, it will start to be charged, enabling it to function as a power source in the event of a power failure.
- When you carry out a simplified power failure voice call operation, the display on the main unit will light up for 30 seconds.
- During a power failure, the display and lamps will go out. If the display does not light up when you pick up the handset, it means that the battery has completely run down. (Unless you carry out an pushbutton operation, the display will go out after about 30 seconds.)

## Setting to enable you to make a simplified power failure voice call from the portable handset

- Carry out the following operation from the main unit. (This operation cannot be performed during a power failure.)

1 Press  (Function/Set).

2 Press    .

3 Press  (Search button) to select “親機・子機”  
(Main unit/Portable handset).

停電時動作  
親機のみ  
親機・子機

4 Press  (Function/Set).

5 Press  (Stop).

## Making a voice call on the main unit

- During a call, when the battery almost completely runs down, a beep will be heard every four seconds from the receiver of the handset.

1 Lift the handset.

2 ■ **Making a voice call by entering a telephone number**  
When “電話番号?” appears on the display, dial the number.

■ **Making a voice call by redialing the last party that you called**

Press  (Redial).

■ **Making a voice call using the phonebook**

① Carry out steps 1 to 3 of “Making a voice call using the phonebook” on page 12.

② Press  (Make a call).

■ **Making a voice call using the speed dialer**

① Press  (Speed dialer).

② Press  (Search button) repeatedly to select the desired name.

③ Press  (Make a call).

## Making a voice call on the portable handset

- If a power failure occurs during a voice call or when the line is on hold, the connection will be broken.

1 Lift the portable handset from the charger, then press  (Talk).

2 ■ **Making a voice call by entering a telephone number**  
Dial when you hear a steady tone.

■ **Making a voice call using the phonebook**

See “Making a voice call using the phonebook” on page 14.

■ **Making a voice call using the one-touch dialer**

See “Making a voice call using the one-touch dialer” on page 15.

## ■ Rough guide to the usable period (when the ambient temperature is 20 °C) after the completion of charging (approx. 10 hours)

Setting the operation to take place in the event of a power failure	Continuous voice call time	Standby period*
“親機のみ”(Main unit)	for about 1 hour	for about 24 hours
“親機・子機”(Main unit/Portable handset)	for about 1 hour	for about 5 hours

\* The standby period will decrease when the telephone rings or during a voice call.

- After a power failure has occurred, the usable period will be reduced until the battery is fully recharged again.
- When the battery inside the main unit runs down, you cannot make a voice call from the portable handset even if there is a charge remaining in the battery inside the portable handset. Also, if the charge in the battery inside the portable handset is low, the above period will be reduced further.

# Specifications

KX-PD601DL KX-PD601DW	Main unit	Portable handset (KX-FKD502)	Battery charger
Power supply	AC 100 V (50 Hz/60 Hz)	Ni-MH battery (Part no. KX-FAN55) DC 2.4 V, 650 mAh	AC 100 V (50 Hz/60 Hz)
Power consumption	Transmission: Approx. 10 W Reception: Approx. 17 W Copy: Approx. 17 W Standby: Approx. 0.7 W Maximum*1: Approx. 120 W		<ul style="list-style-type: none"> <li>Charging: Approx. 0.8 W</li> <li>Standby: Approx. 0.3 W (When the portable handset is off the charger.)</li> </ul>
Dimensions (H x W x D)	Approx. 86 x 296 x 210 mm (without handset, projections) Approx. 256 x 296 x 240 mm (recording paper tray opened, without handset, projections)	Approx. 175 x 48 x 30 mm	Approx. 47 x 73 x 90 mm
Mass (Weight)	Approx. 2.4 kg (5 m ink film installed)	Approx. 150 g (battery installed)	Approx. 155 g
Operating environment	5 °C – 35 °C, 45 % – 85 % RH (Relative Humidity)		

KX-PD601DL KX-PD601DW	Main unit
Applicable line	Public Switch Telephone Network (Pulse/Tone), F-Net, NCC Lines
DC resistance	280 Ω
Compatibility	G3 compatible
Document size	A4–A5 (Max. 210 mm in width, Max. 500 mm in length)
Effective scanning size	208 mm (A4)
Effective printing size	202 mm (A4 size plain paper)
Transmission time	Approx. 15 s/page (Original mode)*2
Modem speed	9,600 / 7,200 / 4,800 / 2,400 bps; Automatic fallback
Halftone level	64-level
Scanning density	Horizontal: 8 pels/mm Vertical : 7.7 lines/mm (Fine/Photo), 3.85 lines/mm (Standard)
Scanner type	Contact image sensor
Printer type	Thermal transfer printing on plain paper
Data compression system	Modified Huffman (MH), Original mode
Recording paper size	A4: 210 mm x 297 mm (Plain paper)
Answering device	Greeting message: Digital recording system (up to 20 sec.) Pre-recording greeting message ICM Recording: Digital recording system (Approx. 12 min. in total)
SD Memory Card capacity	Image data (such as received faxes) : Max. 1,000 data/Max. Approx. 50,000 sheets*3 using 32 GB SDHC Memory Card Audio data (such as recorded messages): Max. 1,000 data/Max. Approx. 1,101 hours using 32 GB SDHC Memory Card
SD Memory Card format	FAT16/FAT12 (SD Memory Card), FAT32 (SDHC Memory Card)
Memory capacity	Max. Approx. 50 pages (Only receiving fax etc.)*3 Max. Approx. 12 min. (Only recording message)
Power source for use during a power failure	Ni-MH battery (Part no. KX-FAN55) DC 2.4 V, 650 mAh

\*1 When copying a 100 % black document.

\*2 Transmission speed is based on an A4-size document of 700 characters sent in standard resolution at 9,600 bps. The actual transmission speed depends upon the contents of the page, resolution, telephone line conditions and capability of the other party's machine.

\*3 The memory capacity is based on an A4-size document of 700 characters sent in standard resolution (8 x 3.85 lines/mm).