

Facsimile

## Quick Reference Guide

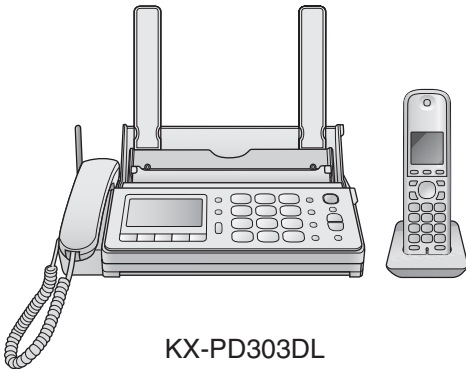

KX-PD303DL

Model No. **KX-PD303DL**  
**KX-PD303DW**

Main unit: KX-PD303  
Portable handset: KX-FKD403

Thank you for purchasing a Panasonic product.

### Table of Contents

Finding the controls .....	2
Installations and connections .....	4
Setting your fax telephone number .....	7
Setting your logo to the main unit .....	8
Character input and command key table .....	9
Voice guide .....	10
Automatic dialing on the main unit.....	11
Recording a telephone conversation on the main unit.....	12
Automatic dialing on the portable handset (KX-FKD403).....	13
Recording a telephone conversation on the portable handset (KX-FKD403)...	14
Intercom.....	15
Sending faxes .....	16
Coping documents.....	16
Receiving faxes .....	17
Operating the built-in answering device.....	20
Call block .....	22
Specifications .....	23

- This guide explains some basic features and operations, but not all of them.  
For further details, see the Japanese operating instructions.
- This product is designed for use in Japan.  
Panasonic cannot provide service for this product if used outside Japan.
- KX-PD303DL includes 1 portable handset and 1 main unit.  
KX-PD303DW includes 2 portable handsets and 1 main unit.
- Any details given in this guide are subject to change without notice.

**This unit is equipped with the voice guide features. (Japanese only)**  
**For details about voice guide, please see page 10.**

# Finding the controls

## Main unit

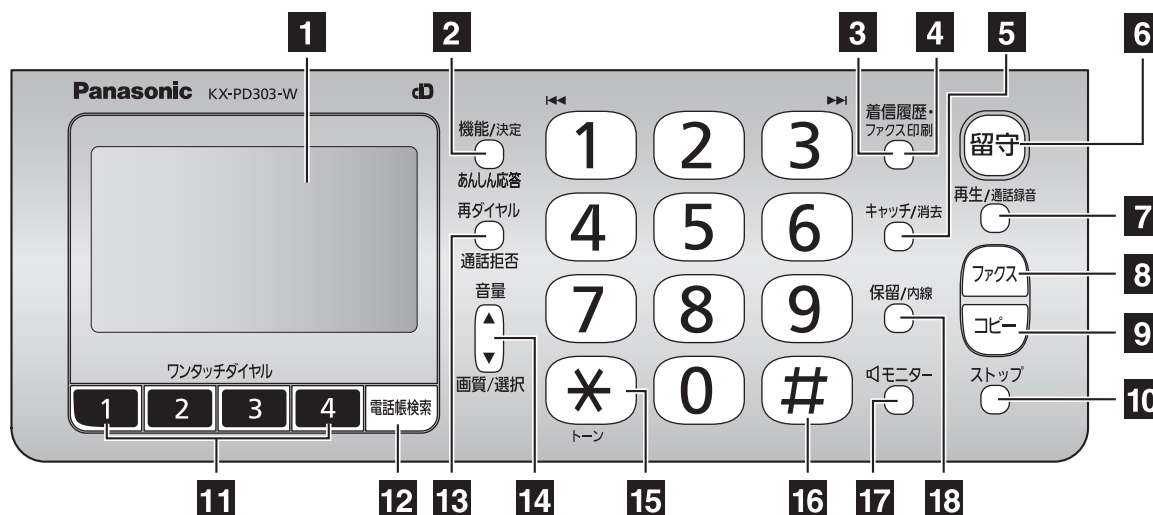

### 1 Liquid crystal display

### 2 Function/Set button

To register a function or apply a setting.

#### Secure button

While the unit is ringing, press this button. The unit announces a message to the caller. The message is announced in Japanese and means “This unit is currently set to Caller Verifying mode. Could you please speak out your name?”.

- To talk to the caller, lift the handset.
- To hang up, press **\***.

### 3 Caller ID Log/Fax Print button starts a search in

- the Number Display (Caller ID) log.
- the fax list stored in memory.
- printing a fax.

### 4 Caller ID Log/Fax Print indicator lights when

- a call was missed. (For Number Display service users.)
- a fax was stored in memory.

### 5 Flash button (For call waiting service users.)

#### Erase button

### 6 Auto Answer button & indicator

- light on: answering device activated.
- light off: used as a regular telephone.

### 7 Playback button plays back recorded messages.

#### Record button records a telephone conversation.

- To record the previous 1 minute of telephone conversation, press **再生/通話録音** (Playback/Record) → **#**.
- To stop recording, press **ストップ** (Stop).

### 8 Fax button starts faxing.

### 9 Copy button starts copying.

### 10 Stop button

### 11 One-touch Dial buttons

### 12 Phonebook button

To use the phonebook.

### 13 Redial button

To redial the telephone numbers in the redial list. The last 10 telephone numbers dialed are stored in memory.  
**Block** button for undesired calls

### 14 Volume control button

To adjust the volume (see below).

■ To adjust the **ringer volume** when the unit is on standby, press **音量** (Volume) → **音量** (Volume) (Select “**ベル**” (Ring))

→ **機能/決定** (Function/Set) → **音量** (Volume) (press repeatedly) → **ストップ** (Stop).

■ To adjust the **receiver volume** while talking, press **音量** (Volume) repeatedly.

■ To adjust the **speaker volume** while listening to the recorded messages or using the monitor, press **音量** (Volume) repeatedly.

**Resolution** button selects the resolution when faxing or copying.

#### Select button

### 15 Tone button switches to tone dialing.

### 16 Sharp button

### 17 Monitor button

### 18 Hold/Intercom button

# Finding the controls





## Portable handset (KX-FKD403)

### How to use key

 ● To redial the telephone numbers in the redial list. The last 10 telephone numbers dialed are stored in memory.

 ● To start a search in the Number Display log. (For Number Display service users.)

 ● To adjust the volume.

- To adjust the ringer volume when the portable handset is on standby, press  (Select “ヨビダツオノリヨウ”) →  →  (press repeatedly) →  or .

- To adjust the receiver volume while talking, press  repeatedly.

- To adjust the speaker volume while listening to the recorded messages or using the speakerphone, press  repeatedly.

### スピーカーホン

 ● To use the speakerphone.

### 内線保留

- To put a call on hold.
- To page the main unit and/or portable handset(s).



- To make/answer calls.



- To end a call.
- To end or exit from editing or other operations.

### Earpiece

When talking on the telephone, ensure that the earpiece is at the position of your ear.

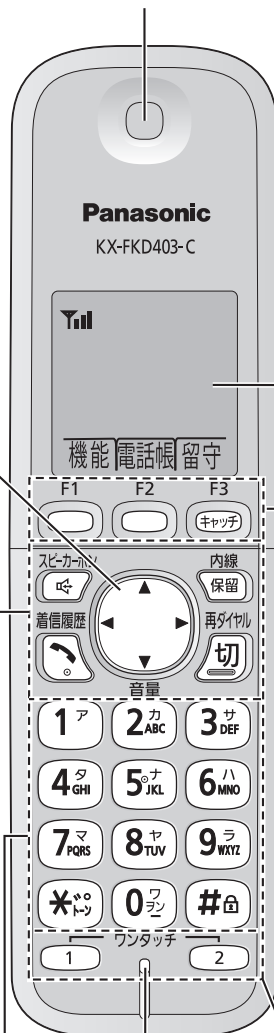



### Microphone

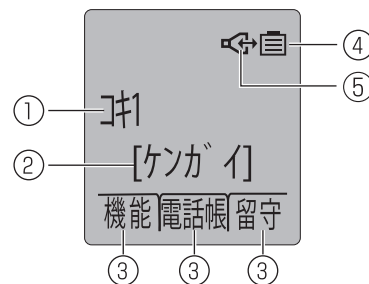

Do not cover the microphone while talking.

### Liquid crystal display



- ① ..... Portable handset number and name
- ② ..... No link to the main unit
- ③ ..... Function menu that is controlled by ,  or 
- ④ ..... Battery strength
- ⑤ ..... When using the speakerphone

### How to use , , buttons

,  and  buttons refer to the function displayed on the bottom of the display. They function differently depending on the mode.

- To answer a second call on the other call, press . (For call waiting service users.)



- To make a voice call using One-touch dialer.

### Dial buttons



Tone button

- To switch to tone dialing.



Sharp button

Key lock button

- To lock the portable handset so that no calls or settings can be made. To turn key lock on, press this button for about 3 seconds until a single beep is heard.
- To turn key lock off, press this button for about 3 seconds until a single beep is heard.

# Installations and connections

## Installing the ink film

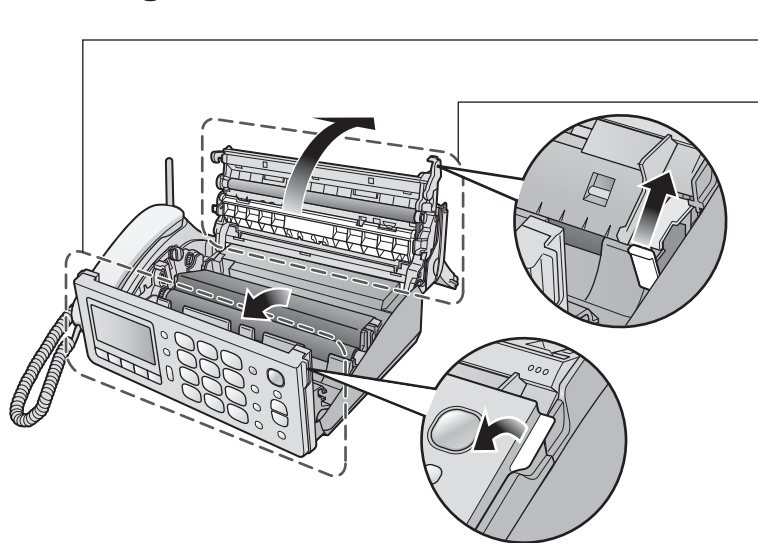

- 1** Open the control panel.
- 2** Pull up the green lever and open the back cover.

Insert the orange gear into the left slot of the main unit.

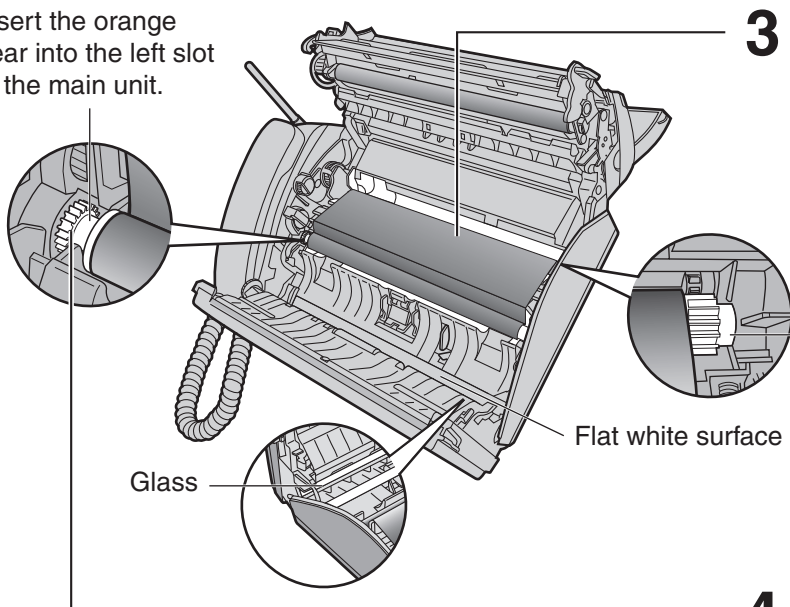

- 3** Insert the ink film.
  - Do not place the ink film on the back side of the control panel. Any ink adhering to the glass or flat white surface may cause black or white lines to appear on the recording paper or the recipient's fax.

Insert the white gear into the right slot of the main unit.

Flat white surface

Glass

- 4** If the ink film is slack, tighten it by winding this gear (orange).

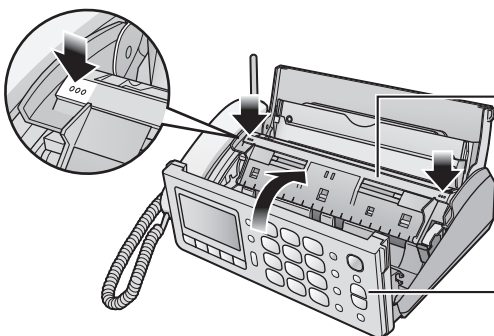

- 5** Close the back cover pressing "○○○" down on both sides until it clicks into place.

- 6** Close the control panel.

• When the unit runs out of ink film, the following message will be displayed.

フィルム/コウカンカ ヒツヨウ  
フィルム (KX-FAN190) ヲ  
オカイモトメタ サイ U23

Install a new ink film.

Replacement ink film:	
<b>KX-FAN190</b> (15 m)	¥714
<b>KX-FAN190W</b> (15 m x 2)	¥1,208
<b>KX-FAN191</b> (15 m)*1	¥893
<b>KX-FAN191W</b> (15 m x 2)*1	¥1,523

\*1 KX-FAN191/KX-FAN191W leaves a fainter print trail on the film than KX-FAN190/KX-FAN190W does.

· As of June 2013

· Tax included

# Installations and connections

## Installing recording paper (A4 size)

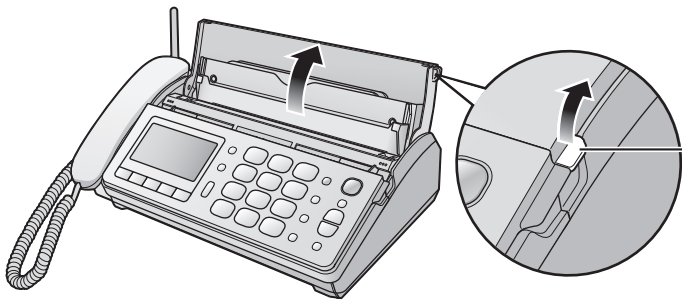

**1** Open the recording paper tray.

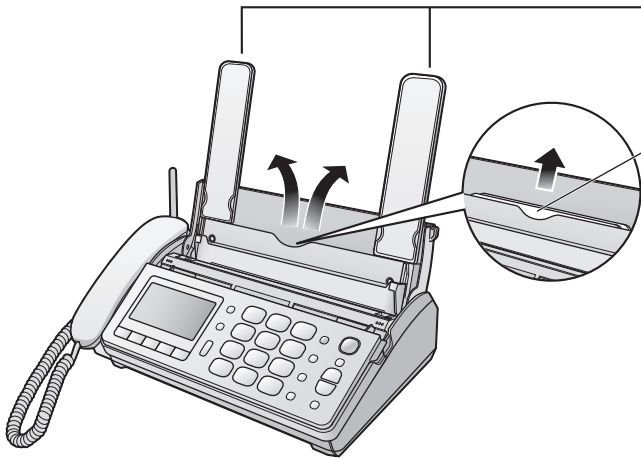

**2** Set up the recording paper stands.

Pull out the front stand first.

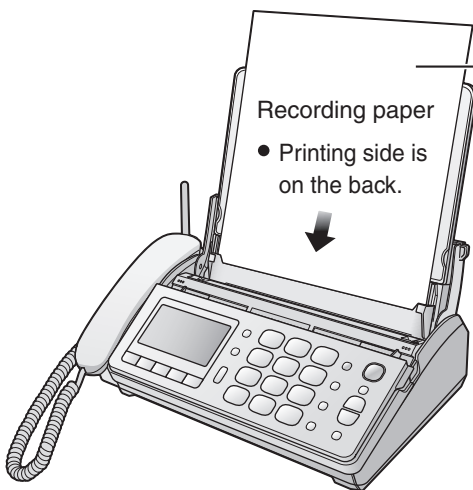

**3** Insert the recording paper into the recording paper tray. (Up to 15 sheets)

- Fan the stack of recording paper.

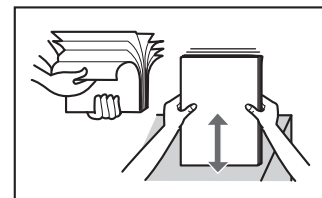

## Folding the recording paper tray

① Remove the recording paper and fold the recording paper stands in.



② Close the recording paper tray.



# Installations and connections

## Connecting the main unit

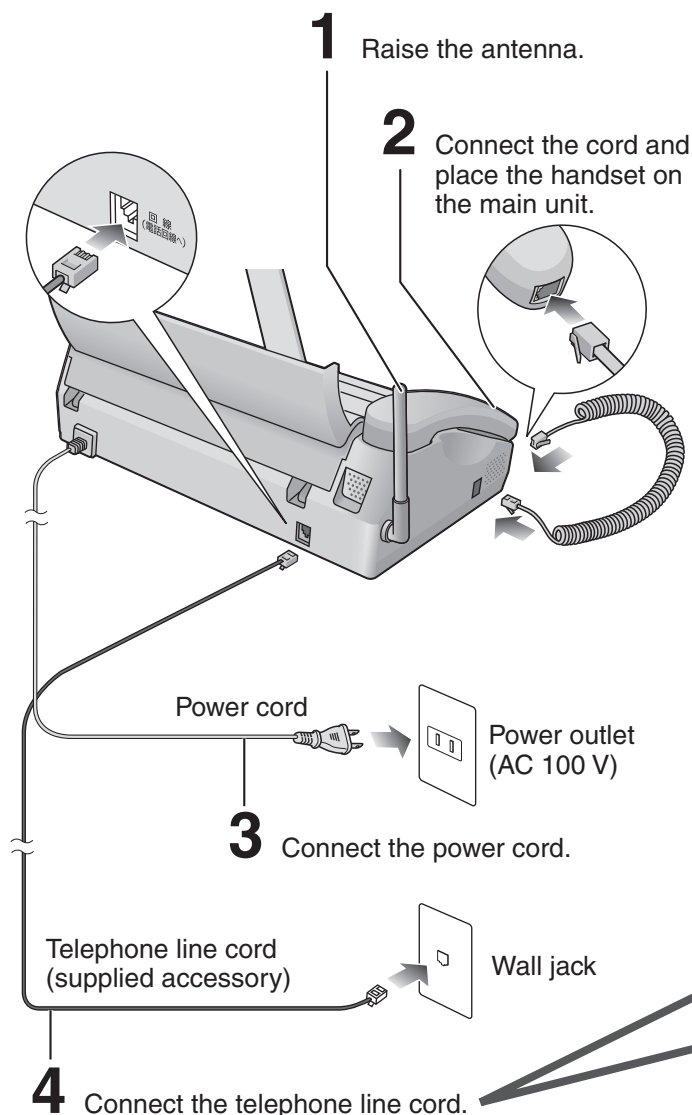

### After connecting...

- This unit will automatically select the dialing mode (Pulse/Tone).
- When the following is displayed, press  (Function/Set) to set the date and time.
 

ヒツケ・シ`コクヲ
セツテイ スルニハ
[キノウ]オス
- Enter the correct year/month/day.
 

**Example: October 1, 2013**

 Press      .
- Enter the correct hour/minute in a 24-hour clock entry.
 

**Example: 15:45 (3:45 PM)**

 Press    .
- Press  (Function/Set).
- When the following is displayed, press  (Stop).

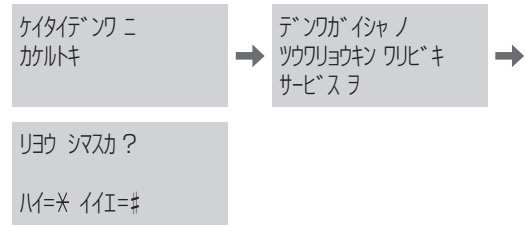

### ↓ If you cannot make a call...

Set the dialing mode with the main unit.

- Press  (Function/Set).
- Press    .
- Press  (Function/Set).
- Press  (Select button) repeatedly until the desired setting is selected.
 

**Example :**

カ`イ`セ`ン` シ`ユ`ハ`ツ`	●ジ`ト`ウ` : Auto (Default)
20	フ`ツ`シ` : Tone
	20 : Pulse (20 PPS)
	10 : Pulse (10 PPS)
- Press  (Function/Set).
- If you have selected “フ`ツ`シ`”, “20” or “10”, press  (Stop).

### ■ To adjust the date and time

- Press  (Function/Set), then press    .
- Press  (Function/Set).
- Enter the correct year/month/day/hour/minute.
- Press  (Function/Set), then press  (Stop).

# Installations and connections

## Setting up the portable handset (KX-FKD403)

- 1** Press  on the battery cover and slide the cover off.

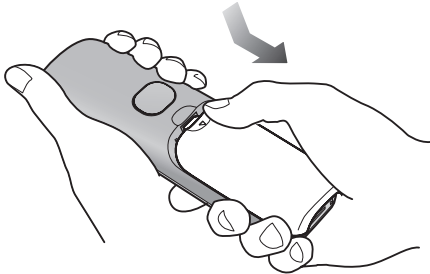

- 2** Insert the battery into the compartment and close the battery cover.

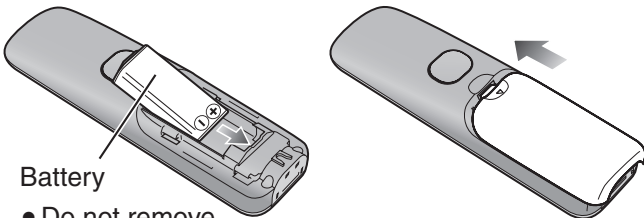

Battery

- Do not remove the orange vinyl film.

- 3** Connect the charger to the power outlet, then place the portable handset on the charger for about **10 hours**.

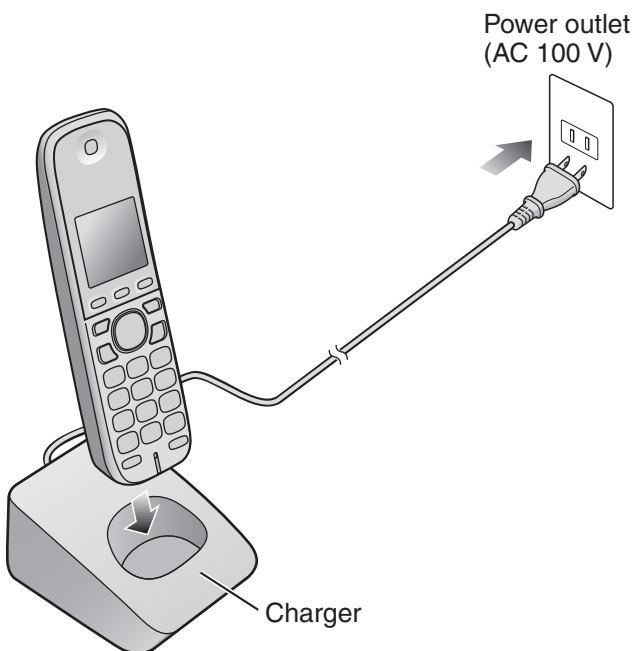

Charger

- After your Panasonic battery is fully charged, it will last up to about 5 hours of conversation.

# Setting your fax telephone number

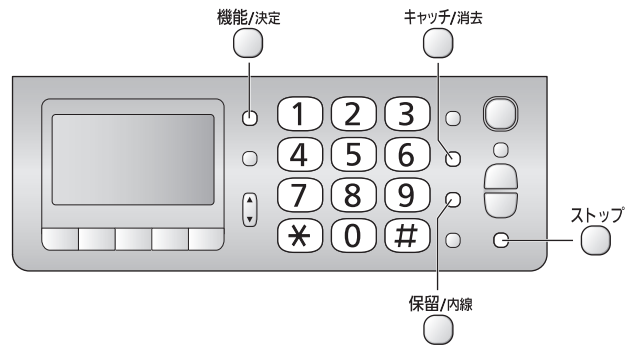

- 1** Press  (Function/Set).

キノウ トウロク モード



- 2** Press    .

アナタノ デンワハンゴウ

- 3** Press  (Function/Set).

- 4** Enter your fax telephone number, up to 20 digits.  
**Example: +098 7654..**

アナタノ デンワハンゴウ?  
+098 7654..

- The  (Tone) button replaces the digit with “+”.
- The  (Hold/Intercom) button replaces the digit with a space.
- To correct a mistake, press  (Flash/Erase).

- 5** Press  (Function/Set).

トウロク シマシタ

- 6** Press  (Stop).

# Setting your logo to the main unit

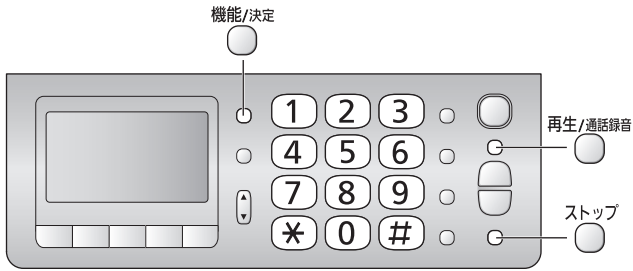

**1** Press (Function/Set).

キノウトウロク モード

**2** Press .

アナタノ ナマイ

**3** Press (Function/Set).

アナタノ ナマイ? [カナ]

Cursor

**4** Enter your logo, up to 30 characters, using the dial keypad.

- To enter Alphabets easily, press (Playback/Record) repeatedly and select "AB".
- For details, see the table on page 9 for instructions.

## Example: Micah

**1.** Press once.

アナタノ ナマイ? [AB]

M | Cursor

**2.** Press six times.

アナタノ ナマイ? [AB]

Mi |

**3.** Press six times.

アナタノ ナマイ? [AB]

Mi |

**4.** Press to move the cursor to the next space and press four times.

アナタノ ナマイ? [AB]

Mi | a

**5.** Press five times.

アナタノ ナマイ? [AB]

Mi | a |

**5** Press (Function/Set).

トウロク シマシタ

**6** Press (Stop).



# Character input and command key table

Pressing the dial keys will select a character as shown below.

Character		Katakana	Alphabets	Numbers
Display of the main unit and the portable handset		[カナ]	[AB]	[12]
Dial key				
(Main unit) ①	(Portable handset KX-FKD403) ①	アイウエオ アイウエオ	@ . _ - & \$ ¥ % + = ~ ^	1
②	②	カキクケコ	A B C a b c	2
③	③	サシスセソ	D E F d e f	3
④	④	タチツテトッ	G H I g h i	4
⑤	⑤	ナニヌネノ	J K L j k l	5
⑥	⑥	ハヒフヘホ	M N O m n o	6
⑦	⑦	マミムメモ	P Q R S p q r s	7
⑧	⑧	ヤユヨャュョ	T U V t u v	8
⑨	⑨	ラリルレロ	W X Y Z w x y z	9
⑩	⑩	ワランー	! ? / - * # , ; :   . ' " ( ) [ ] { } < > 「 」	0
✳	✳	ゝ っ っ っ っ	、 。	
<b>Command keys</b>		再生/通話録音 (Main unit),  (Portable handset) F1	Used to change the character input mode.	
		# (Main unit)*1,  (Portable handset)	Used to move the cursor to the left and right.	
		キャッチ/消去 (Main unit),  (Portable handset) F3	Used to delete a character. To delete the character on the cursor and one(s) to its right, press this button for 2 seconds or more.	
		保留/内線 (Main unit),  (Portable handset)	Used to insert a space.	

\*1 On the main unit, the cursor cannot be moved to the left.

- The characters on the display are somewhat different from those shown in the character input and command key table.

# Voice guide

## Operation guide

The unit starts the following voice guidance in Japanese:

Operations	To cancel the operation guide (using the main unit)
Send a fax	
Copy	
Store telephone numbers in the one-touch dialers	
Make a call using the phonebook/redial/one-touch dialer/caller ID log	
Print fax documents from the memory	
Change the ink film	The operation guide for changing the ink film cannot be prevented from starting.

## Reading-out dial

The unit announces the dialed number in Japanese.

### • To cancel the reading-out dial



# Automatic dialing on the main unit

## Storing names and telephone numbers in the phonebook

You cannot store directly in the phonebook of the main unit. You need to transfer the stored phonebook of the portable handset to the main unit.

For storing the phonebook entries of the portable handset, see page 13.

- To transfer a phonebook entries from the portable handset to the main unit

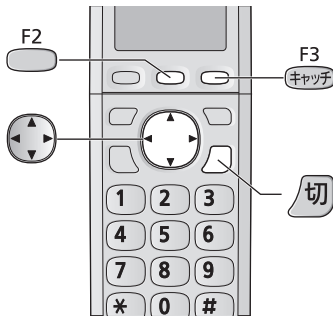

- 1 Press .
- 2 Press .
- 3 Press (Search button) repeatedly until “オヤキ” is displayed, then press .

Example :

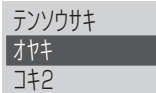

## 4 ■ To transfer a stored phonebook entry individually

- ① Press .
- ② Press (Search button) repeatedly until the desired name is displayed.
- ③ Press .
  - To transfer other stored phonebook entries, repeat steps ② to ③.
- ④ When transferring is finished, press (Off).

## ■ To transfer all of the stored phonebook entries

- ① Press (Search button) repeatedly to select “イッセイ”.
- ② Press twice.
- ③ When transferring is finished, press (Off).

## Making a voice call using the phonebook

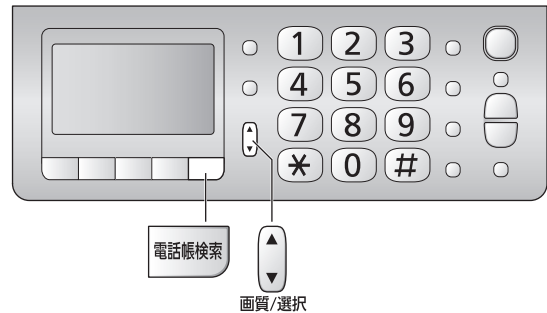

- 1 Press (Phonebook).
- 2 Press (Select button) to select the desired name.
- 3 Lift the handset.

## Erasing a stored name and number in the phonebook

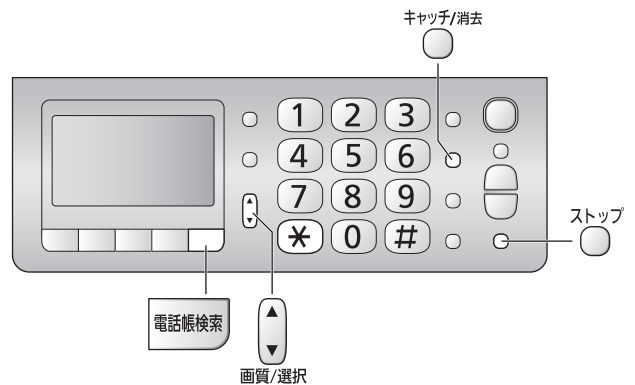

- 1 Press (Phonebook).
- 2 Press (Select button) to select the desired name to delete.
- 3 Press (Flash/Erase).
- 4 Press (\*).
- 5 Press (Stop).

## Automatic dialing on the main unit

### Storing telephone numbers in the one-touch dialer

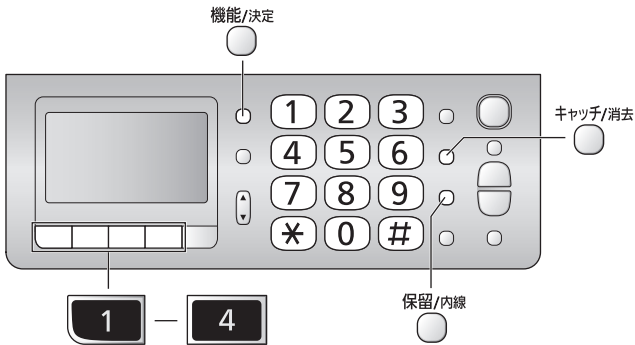

1 Press (Function/Set).

2 Press the one-touch dial button ( — ).

**Example: One-touch dial button 1**

ワンタッチ 1  
トウロクワ カイシジマス

3 Enter the telephone number, up to 24 digits.

- To correct a mistake, press (Flash/Erase).
- To insert a space, press (Hold/Intercom).
- When the number exceeds 24 digits, an alert sounds.

4 Press (Function/Set).

### Making a voice call using the one-touch dialer

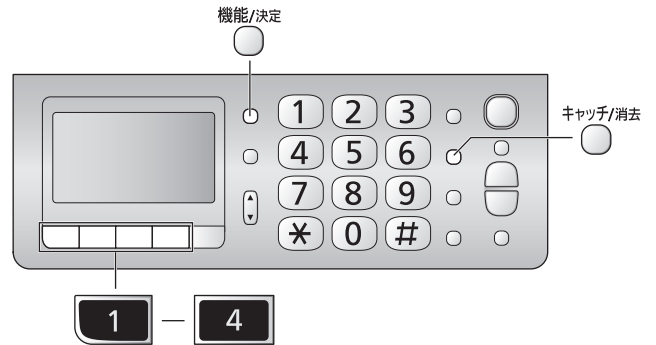

1 Lift the handset.

2 Press the one-touch dial button ( — ).

- You can also make a call by pressing the one-touch dial button first.

### Erasing a stored number in the one-touch dialer

1 Press (Function/Set).

2 Press the one-touch dial button ( — ).

3 Press (Flash/Erase) for about 2 seconds.

4 Press (Function/Set).

## Recording a telephone conversation on the main unit



1 While talking, press (Playback/Record).

2 Press .

3 Press (Cancel the precaution voice message) and the recording starts.

4 Press (Stop) to end the recording.

# Automatic dialing on the portable handset (KX-FKD403)

## Storing names and telephone numbers in the phonebook

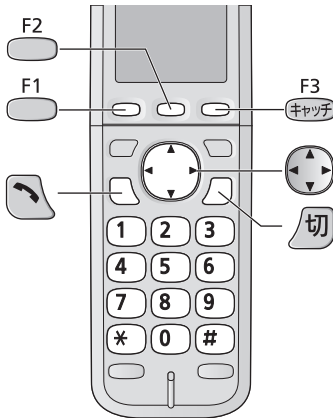

**1** Press **F2**.

**2** Press **F1**.

- "XXX" shows the number of remaining stations you can store.
- You can store up to 150 station numbers, including 4 pre-stored station numbers.

イチラン ケンサク
ナマエ ケンサク
グループ ケンサク

ナマエ?
アキ XXXケン

**3** Enter the name, up to 12 characters (see the table on page 9 for instructions).

**4** Press **F2**.

**5** Enter the telephone number, up to 24 digits.

- To correct a mistake, press **F3** (キヤッチ).

**6** Press **F2**.

**7** Press **(Search button)** to select a group.

**8** Press **F2**.

- To store other items, repeat steps 3 to 8.

**9** Press **(Off)** to exit.

## Making a voice call using the phonebook

**1** Press **F2**.

**2** Press **(Search button)** repeatedly until "イチラン ケンサク" is displayed.

**3** Press **F2**.

**4** Press **(Search button)** repeatedly until the desired name is displayed.

**5** Press **(Talk)**.

## Editing a stored name or number in the phonebook

**1** Press **F2**.

**2** Press **(Search button)** repeatedly until "イチラン ケンサク" is displayed.

**3** Press **F2**.

**4** Press **(Search button)** repeatedly until the desired name is displayed.

**5** Press **F2**.

**6** Edit the name (see the table on page 9 for instructions).

- If you do not need to edit the name, skip to step 7.

**7** Press **F2**.

**8** Enter the correct telephone number.

- If you do not need to edit the telephone number, skip to step 9.

**9** Press **F2**.

**10** Press **(Search button)** to select a group.

**11** Press **F2**.

**12** Press **(Off)** to exit.

# Automatic dialing on the portable handset (KX-FKD403)

## Storing names and telephone numbers in the one-touch dialer

You can store up to 2 phonebook entries as the one-touch dialer.

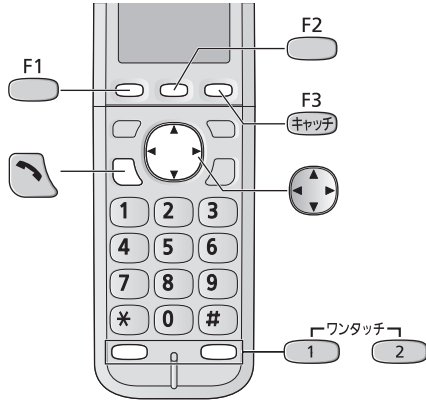

- 1 Press **F1**.
- 2 Press the one-touch dial button ( **ワンタッチ 1** or **ワンタッチ 2** ).

**Example: One-touch dial button 1**

1. ミトウロク  
トウロクハ [F2]オス

- 3 Press **F2**.
- 4 Press **Search button** (Search button) repeatedly until “イチロク ケンサク” is displayed.
- 5 Press **F2**.
- 6 Press **Search button** (Search button) to select the desired name from the phonebook.
  - To check the registered items in the phonebook entry, press **F1** → **Search button** (Search button) repeatedly to view the name/telephone number/group. (To exit, press **F1**.)
- 7 Press **F2**.

## Making a voice call using the one-touch dialer

- 1 Press **Call button**.
- 2 Press the one-touch dial button ( **ワンタッチ 1** or **ワンタッチ 2** ).
  - You can also make a call by pressing the one-touch dial button first.

## Erasing a stored name and number in the one-touch dialer

- 1 Press **F1**.
- 2 Press the one-touch dial button ( **ワンタッチ 1** or **ワンタッチ 2** ).
  - To check the telephone number, press **F1**.
- 3 Press **F3** (**キャッチ**).
- 4 Press **F1**.

# Recording a telephone conversation on the portable handset (KX-FKD403)

- 1 While talking, press **F1**.
- 2 Press **Search button** (Search button) repeatedly until “ツウウ ロクオン” is displayed, then press **F2**.
- 3 Press **Search button** (Search button) repeatedly until “シナイ” is displayed, then press **F2** and the recording starts.

- 4 ■ To end the recording
  - ① Press **F1**.
  - ② Press **Search button** (Search button) repeatedly until “ロクオン チュウシ” is displayed, then press **F2**.

# Intercom

An intercom is available between the portable handsets or between the main unit and portable handset(s).

## Using the main unit:

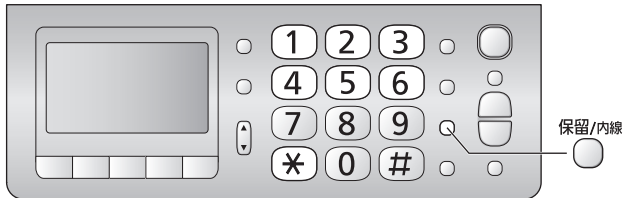

### 1 ■ For single portable handset users

① Press  (Hold/Intercom).

コキ1

② Lift the handset.

### ■ For multiple portable handsets users

① Press  (Hold/Intercom).

- ② Call the portable handsets in the following ways:
- To call a specific portable handset, press the portable handset number (1 to 6) which you want to call.
  - To call all the portable handsets, press \*.

③ Lift the handset.

### 2 Start talking.

ナイセン ツウワ チュウ

3 To end the intercom call, place the handset on the main unit.

## Using the portable handset (KX-FKD403):



### 1 ■ For single portable handset users

Press  (Hold/Intercom).

### ■ For multiple portable handsets users

① Press  (Hold/Intercom).

- ② Call the main unit and/or portable handset(s) in the following ways:
- To call a specific portable handset, press the portable handset number (1 to 6) which you want to call.
  - To call the main unit, press 0.
  - To call the main unit and all the portable handsets, press \*.

### 2 Start talking.

ナイセンツウワ チュウ



3 Press  (Off) to end the intercom call.

# Sending faxes

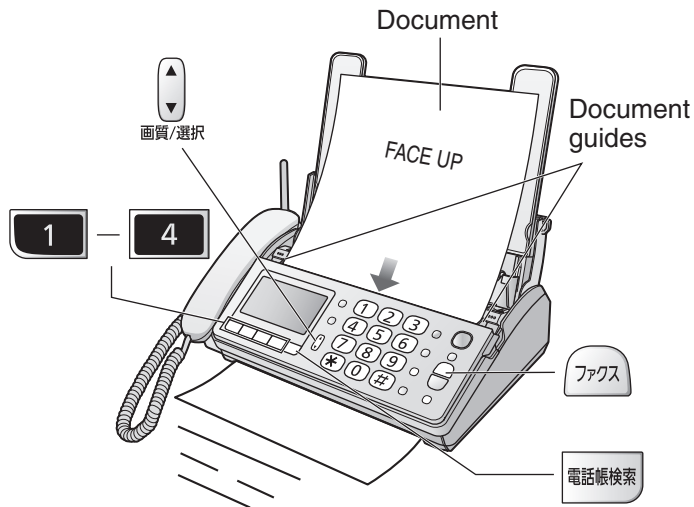

Cancel the voice guide features before sending a fax. (See page 10)

## Sending a fax manually



- 1 Open the recording paper tray, and adjust the width of the document guides (blue) to the size of the document.
- 2 Insert the document (up to 5 pages) FACE UP until a single beep is heard.
- 3 If necessary, press  (Resolution/Select button) repeatedly to select the desired resolution while “カ`シツ=” is displayed (see below).
- 4 Dial the fax number.
- 5 Press  (Fax).
  - The unit will start fax transmission.



### To select the resolution

Select the desired resolution according to the type of document, by pressing  (Resolution/Select button) repeatedly while “カ`シツ=” is displayed. To display “カ`シツ=”, press  (Resolution/Select button).



- |             |   |
|-------------|---|
| カ`シツ=フツウシ`  | (Standard) for printed or typewritten originals with normal-sized characters. |
| カ`シツ=チイサイシ` | (Fine) for originals with minute printing.                                    |
| カ`シツ=シャシシ`  | (Photo) for originals containing photographs.                                 |

## Sending a fax using automatic dialing

### Using the phonebook



- 1 Insert the document (up to 5 pages) FACE UP until a single beep is heard.
- 2 Press  (Phonebook).
- 3 Press  (Select button) repeatedly until the desired name is displayed.
- 4 Press  (Fax).
  - The unit will start fax transmission.

### Using the one-touch dialer

- 1 Insert the document (up to 5 pages) FACE UP until a single beep is heard.
- 2 Press the one-touch dial button (  —  ).

# Copying documents

Cancel the voice guide features before copying a document. (See page 10)

- 1 Install the recording paper (see page 5).
- 2 Insert the document (up to 5 pages) FACE UP until a single beep is heard.
  - If necessary, press  (Resolution/Select button) repeatedly to select the desired resolution while “カ`シツ=” is displayed (see above).
- 3 Press  (Copy).
  - The unit will start copying.



# Receiving faxes



You can select whether to receive faxes on recording paper or in memory.

**Receive on recording paper** : The received fax will be printed on recording paper. When the unit runs out of the recording paper or the ink film, the received fax will be stored in the main unit memory.

**Receive in memory** : The received fax will be stored in the main unit memory. To check the contents, print them. (You cannot check the contents on the display.)

## ■ To receive on recording paper

Insert the recording paper into the recording paper tray beforehand.

## ■ To receive in memory

Remove the recording paper from the recording paper tray.

When new faxes are received in memory,  (Caller ID Log/Fax Print) will light on.

- It will also light on when a call is missed.

(For Number Display service users.)

When you want to print the received faxes, insert the recording paper into the recording paper tray, and print them.

## Receiving a fax manually (AUTO ANSWER off)



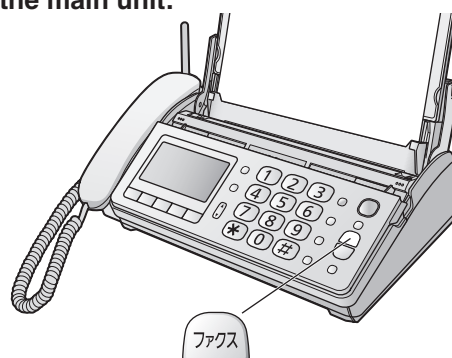

Using the main unit:

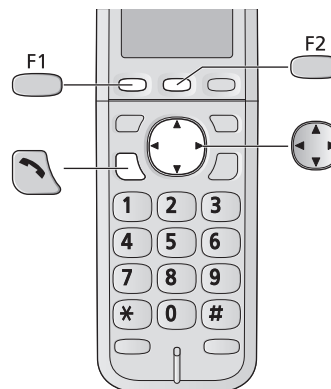

- 1 When you hear a ring, lift the handset to answer the call.
- 2 When:
  - document reception is required,
  - a fax calling tone (slow beep) is heard, or
  - no sound is heard,
 press  (Fax), then place the handset on the main unit.
  - The unit will start fax reception.

Using the portable handset (KX-FKD403):



- 1 When you hear a ring, lift the portable handset from the charger, then press  (Talk) to answer the call.
- 2 When:
  - document reception is required,
  - a fax calling tone (slow beep) is heard, or
  - no sound is heard,
 press .
- 3 Press  (Search button) repeatedly until the “ファクス ｼﾞﾝｼﾞﾝ” is displayed, then press .
- 4 Press .
  - The main unit will start fax reception.

# Receiving faxes

## Receiving a fax automatically (AUTO ANSWER on)



**1** Turn the **留守** (Auto Answer) light on by pressing **留守**.

**2** When receiving a call, the unit will receive a fax document or record a voice message automatically depending on the caller's request.

## Printing all the new faxes received in the memory

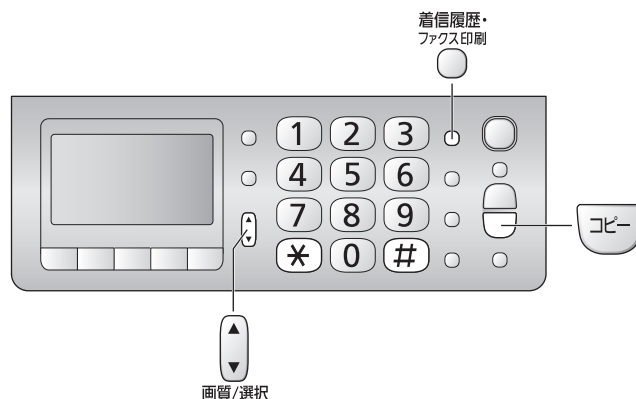

When new faxes are received in memory, the following will be displayed.

ファクスが トド`イテイマス  
[チャクシンリレキ・ファクスイン  
サツ] オス

You can print all the new faxes.

### 1 ■ When not using Number Display Service

Press **着信履歴・ファクス印刷** (Caller ID Log/Fax Print).

### ■ When using Number Display Service

Press **着信履歴・ファクス印刷** (Caller ID Log/Fax Print), then

press **画質/選択** (Select button).

The total number of stored faxes.

ファクス 10ケン  
シンキ(＊マーク) 3ケン  
ケンサクハ [ケツテイ] オス

The number of new faxes.

**2** Press **コピー** (Copy).

### 3 After printing, the following will be displayed.

Do you delete the printed contents?

インサツタ ナイヨウワ  
ショウキョ シマスカ?  
ハイ=＊ イイエ=#

- If you want to delete the faxes, press **＊**.
- If you want to save the faxes, press **#**.

# Receiving faxes

## Printing a specific fax stored in memory

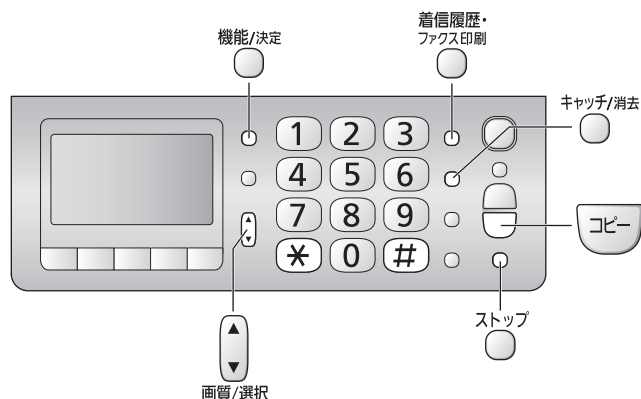

### 1 ■ When not using Number Display Service

Press (Caller ID Log/Fax Print).

### ■ When using Number Display Service

Press (Caller ID Log/Fax Print), then press

(Select button).

ファクス	10ケン
シンキ (*マーク)	3ケン
ケンサクハ [ケツテイ] オス	

2 Press (Function/Set).

3 Press (Select button) to select the desired fax to print, then press (Copy).

4 After printing, the following is displayed.

Do you delete the printed contents? —

- If you want to delete the fax, press .
- If you want to save the fax, press .

## Deleting a specific fax stored in memory

### 1 ■ When not using Number Display Service

Press (Caller ID Log/Fax Print).

### ■ When using Number Display Service

Press (Caller ID Log/Fax Print), then press

(Select button).

ファクス	10ケン
シンキ (*マーク)	3ケン
ケンサクハ [ケツテイ] オス	

2 Press (Function/Set).

3 Press (Select button) to select the desired fax to delete.

4 Press (Flash/Erase).

Do you delete the fax? —

ハイ=\* イイエ=#

or

This fax has not been printed. —

ハイ=\* イイエ=#

5 If you want to delete the fax, press .

- If you want to save the fax, press .

6 If you want to delete other faxes, repeat steps 3 to 5.

7 Press (Stop).

# Operating the built-in answering device

## Recording your own greeting message

You can record your own greeting message. When receiving a call, it will be played to callers instead of the pre-recorded Japanese greeting message.



- 1 Press **機能/決定** (Function/Set).
- 2 Press **# 1 4 7**. ジ サク オウトウ ロクオン
- 3 Press **機能/決定** (Function/Set).
- 4 Press **1** or **2** to select a message number to record to.
  - You can record different greeting messages to “ジサク1” and “ジサク2”.
- 5 Lift the handset.
- 6 Press **機能/決定** (Function/Set) and speak your greeting message after a beep, up to 20 seconds, to the handset.
- 7 Press **ストップ** (Stop) and place the handset on the main unit.
  - Your greeting message will be played back automatically.

## Erasing your own greeting message

- 1 Press **機能/決定** (Function/Set).
- 2 Press **# 1 4 8**. ジ サク オウトウ ショウキョ
- 3 Press **機能/決定** (Function/Set).
- 4 Press **1** or **2** to select a message number to erase.
- 5 Press **\***.

## Activating the answering device

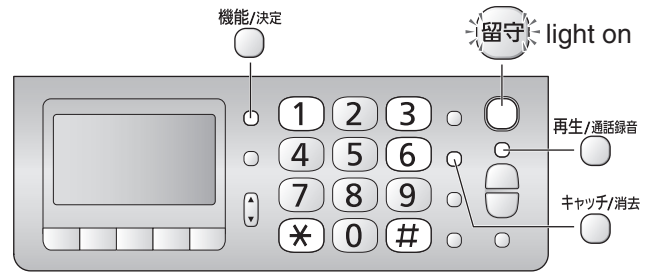

- 1 Turn the **留守** (Auto Answer) light on by pressing **留守**.
  - The greeting message will be played back.  
To change the greeting message, press **#** repeatedly while playing back the greeting message.
  - To record your own greeting message, see the left.
- 2 When receiving a call, a greeting message will be played and the unit will record a voice message.

## Listening to recorded messages

When new messages are recorded, the **留守** (Auto Answer) light will flash.

Press **留守** to listen to recorded messages.

サイセイチュウ 1/ 3ケン  
means recorded — 10月 1日 11:45  
date and time : Oct. 1, 11:45

After the messages are played back, the following will be displayed.

- To erase the messages, press **\*** twice. スヘテノ シンキョウケンヲ  
ショウキョ シマスカ?  
ハイ=\* イエ=#
- To save the messages, press **#**.

# Operating the built-in answering device

## Listening to all of the recorded messages

Press (Playback/Record) when new messages are not recorded.

- When new messages are recorded, only the new messages will be played back.

After the messages are played back, the following will be displayed.

スベテノ ヨウケンヲ  
ショウキョ シマスカ?  
ハイ=\* イイエ=#

- To erase the messages, press twice.

- To save the messages, press .

## Erasing a specific message

Press (Flash/Erase) while listening to the message you want to erase, then press .

## Erasing all of the recorded messages

**1** Press (Function/Set).

**2** Press .

**3** Press (Function/Set).

ヨウケンヲ スベテ  
ショウキョ シマスカ?  
ハイ=\* イイエ=#

**4** Press .

## Operating the answering device from a remote location

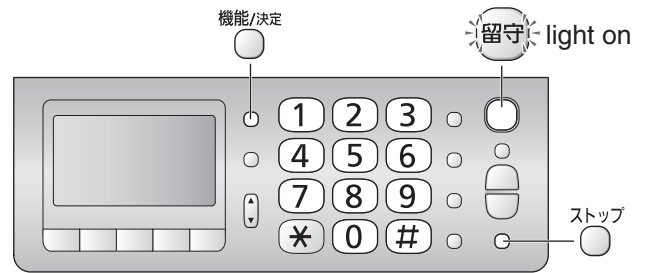

### Preparation: Setting the remote operation ID

1. Press (Function/Set).
2. Press .
3. Press (Function/Set).
4. Enter any 4-digit number (remote operation ID) except \* or #.

Example :

ルステオン アンショウ No. ?  
1234

5. Press (Function/Set).
6. Press (Stop).

### Operation: Listening to a recorded message from a remote location

Turn the (Auto Answer) light on before you go out. Remote operations are available only from a touch tone telephone.

1. Call your unit.
2. Enter the remote operation ID during the greeting message.
3. Press or wait 4 seconds.
  - Only the new recorded messages will be played back.
  - To listen to all the recorded messages, press after the new messages have been played back.

# Call block

## Blocking the incoming calls

Using the main unit:



### To block a call using a message

While the unit is ringing, press (Block).

OR

While you are on an incoming call, press (Block), then press .

- The unit announces a message to the caller twice, then hangs up automatically. The message is announced in Japanese and means “We’re sorry, but your call cannot be connected.”.

### To block a call using chimes

**1** While you are on an incoming call, press (Block).

**2** Press .

- Chime is heard by the caller.

**3** Explain to the caller that a visitor came and hang up.

Using the portable handset (KX-FKD403):

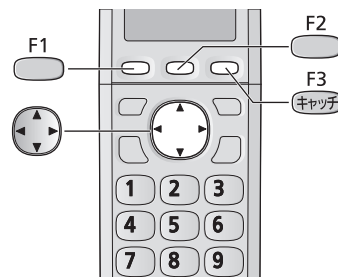

### To block a call using a message

While the unit is ringing, press twice.

OR

While you are on an incoming call,

- 1** Press .
- 2** Press repeatedly until “ツウ キョヒ” is displayed.
- 3** Press .
- 4** Press repeatedly until “オンセイ” is displayed.
- 5** Press .

- The unit announces a message to the caller twice, then hangs up automatically. The message is announced in Japanese and means “We’re sorry, but your call cannot be connected.”.

### To block a call using chimes

**1** While you are on an incoming call, press .

**2** Press repeatedly until “ツウ キョヒ” is displayed, then press .

**3** Press repeatedly until “チャム” is displayed, then press .

**4** Explain to the caller that a visitor came and hang up.

### For Number Display service subscribers

- If you subscribe to Number Display service, the message heard by the caller will change according to the caller’s situation.

**Example:** If the caller requested not to send caller’s information, the message heard by the caller will change to mean “Your telephone number is blocked by service provider. Please call again with adding ‘186’ to the beginning of the telephone number.”.

- When the following is displayed after blocking an incoming call, you can set the unit to block the call from the same telephone number.

#### Using the main unit:

■ To block the call, press .

■ To cancel blocking, press .

- When the following is displayed, press to cancel.

メイワク セツテイ  
シマスカ?  
ハイ=\* イイイ=#

キョヒ セツテイ  
シマスカ?  
ハイ=\* イイイ=#

#### Using the portable handset:

■ To block the call, press .

■ To cancel blocking, press .

- When the following is displayed, press to cancel.

メイワク セツテイ  
シマスカ?

キョヒ セツテイ  
シマスカ?

# Specifications

KX-PD303DL KX-PD303DW	Main unit	Portable handset (KX-FKD403)	Battery charger
<b>Power supply</b>	AC 100 V (50 Hz/60 Hz)	Ni-MH battery (Part no. KX-FAN55) DC 2.4 V, 650 mAh	AC 100 V (50 Hz/60 Hz)
<b>Power consumption</b>	Transmission: Approx. 10 W Reception: Approx. 15 W Copy: Approx. 16 W Standby: Approx. 0.5 W Maximum*1: Approx. 120 W		<ul style="list-style-type: none"> <li>• Charging: Approx. 0.8 W</li> <li>• Standby: Approx. 0.3 W (When the portable handset is off the charger.)</li> </ul>
<b>Dimensions (H x W x D)</b>	Approx. 86 x 296 x 191 mm (without handset, projections) Approx. 256 x 296 x 240 mm (recording paper tray opened, without handset, projections)	Approx. 175 x 48 x 30 mm	Approx. 47 x 73 x 90 mm
<b>Mass (Weight)</b>	Approx. 2.4 kg (5 m ink film installed)	Approx. 150 g (battery installed)	Approx. 155 g
<b>Operating environment</b>	5 °C – 35 °C, 45 % – 85 % RH (Relative Humidity)		

KX-PD303DL KX-PD303DW	Main unit
<b>Applicable line</b>	Public Switch Telephone Network (Pulse/Tone), F-Net, NCC Lines
<b>DC resistance</b>	280 Ω
<b>Compatibility</b>	G3 compatible
<b>Document size</b>	A4–A5 (Max. 210 mm in width, Max. 500 mm in length)
<b>Effective scanning size</b>	208 mm (A4)
<b>Effective printing size</b>	202 mm (A4 size plain paper)
<b>Transmission time</b>	Approx. 15 s/page (Original mode)*2
<b>Modem speed</b>	9,600 / 7,200 / 4,800 / 2,400 bps; Automatic fallback
<b>Halftone level</b>	64-level
<b>Scanning density</b>	Horizontal: 8 pels/mm Vertical : 7.7 lines/mm (Fine/Photo), 3.85 lines/mm (Standard)
<b>Scanner type</b>	Contact image sensor
<b>Printer type</b>	Thermal transfer printing on plain paper
<b>Data compression system</b>	Modified Huffman (MH), Original mode
<b>Recording paper size</b>	A4: 210 mm x 297 mm (Plain paper)
<b>Answering device</b>	Greeting message: Digital recording system (2 messages of up to approx. 20 seconds each) Pre-recording greeting message (2 messages) ICM Recording: Digital recording system (Approx. 12 min. in total)
<b>Main unit memory capacity</b>	Max. Approx. 50 pages (Only receiving fax etc.)*3 Max. Approx. 12 min. (Only recording message)

\*1 When copying a 100 % black document.

\*2 Transmission speed is based on an A4-size document of 700 characters sent in standard resolution at 9,600 bps. The actual transmission speed depends upon the contents of the page, resolution, telephone line conditions and capability of the other party's machine.

\*3 The memory capacity is based on an A4-size document of 700 characters sent in standard resolution (8 x 3.85 lines/mm).

