

# Panasonic

1億人のファクス

# おたくす

KX-PW10CL



Facsimile with Cordless Phone

KX-PW10CL

Model No. KX-PW10CLW

KX-PW10CLW



## Quick Reference Guide

- The digital speaker phone (main unit) allows hands free conversations.
- Automatic dialing (Up to 99 phone numbers can be stored with names.)
- Digital answering machine with flash memory
- Auto cutter

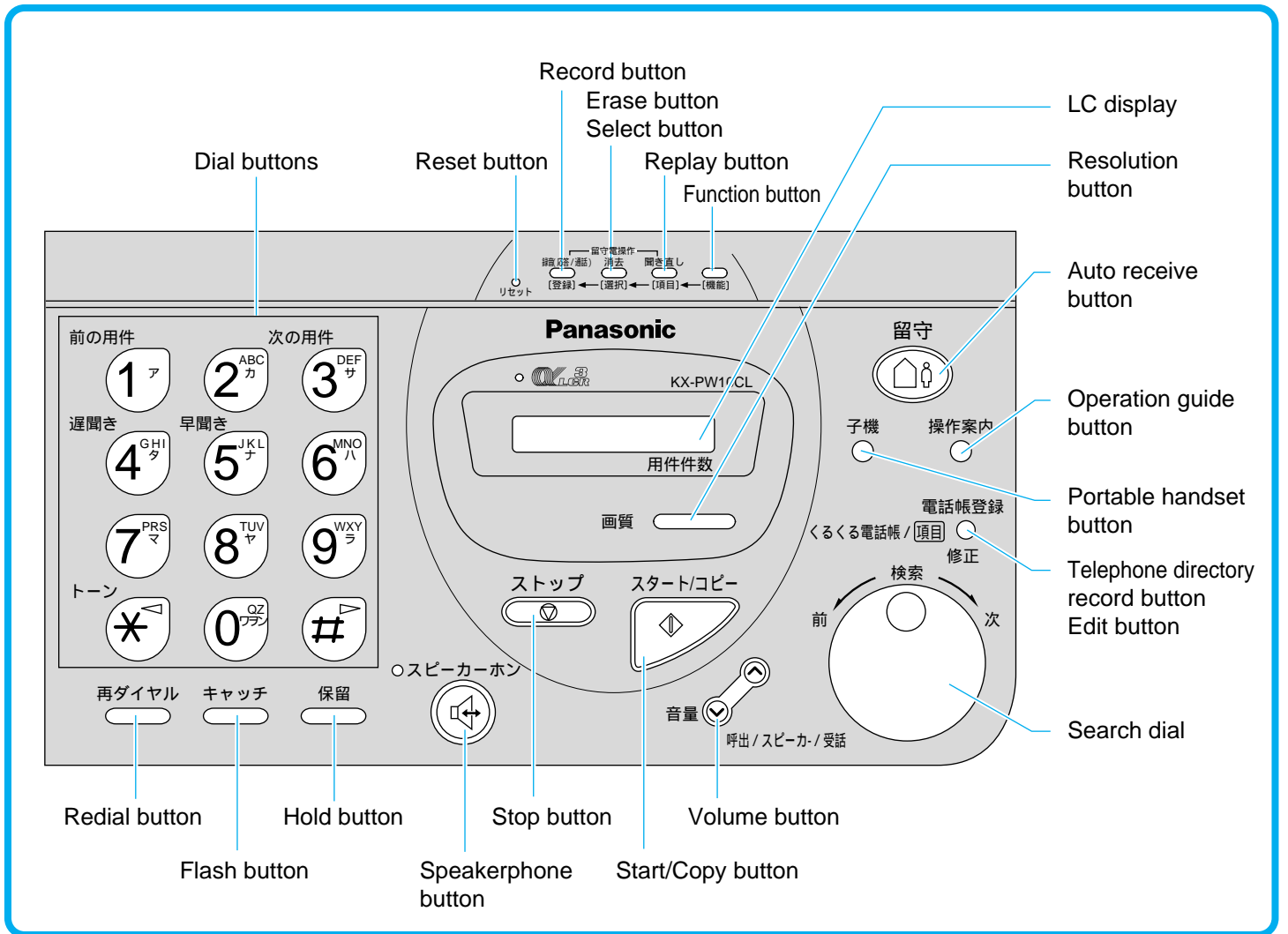

# Preparations

## 1 Installing the recording paper and stacker

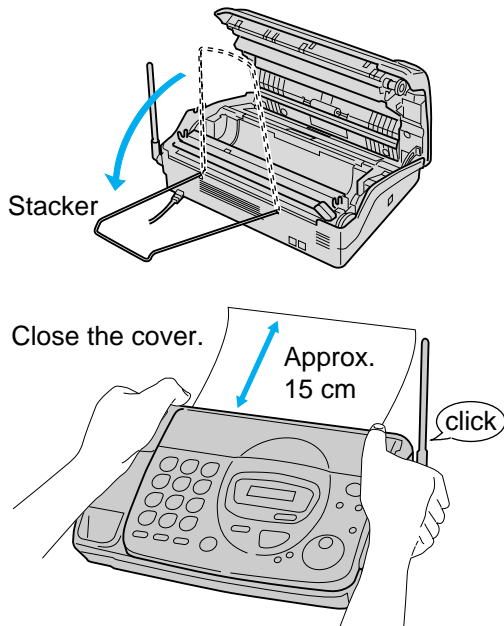
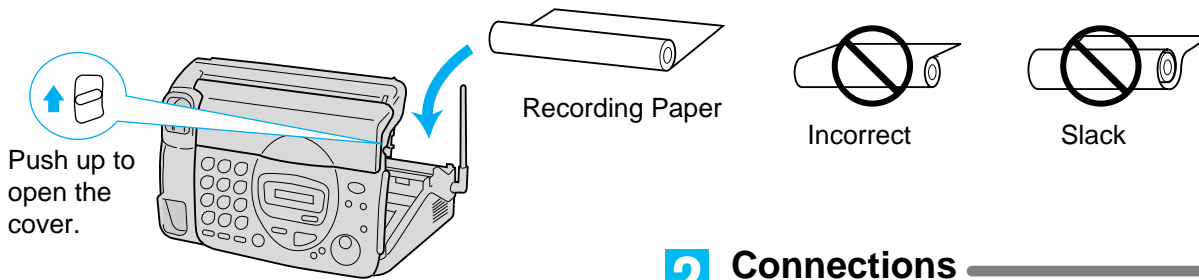

## 2 Connections

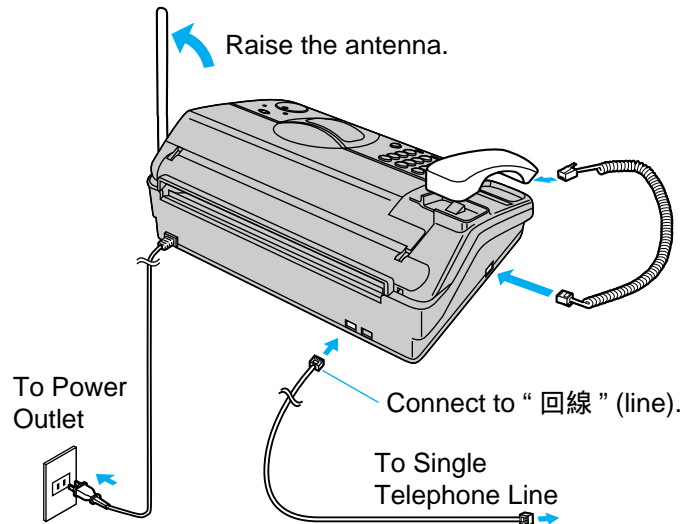

## 3 Automatic dial mode setting

When the power cord and the telephone line cord are connected, the unit will start detecting the dial mode (tone or pulse). If you cannot dial and “カイセン チェック エラー-U61” is displayed, change the dial mode setting.

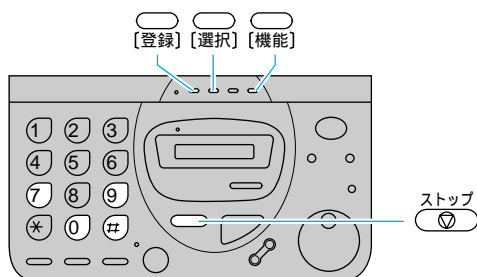

### Changing the dial mode

1. Press **[機能]** (function).
2. Press **# 0 7 9**.
3. Press **[選択]** (select) to select the dial mode (カイセンシユハツ).
4. Press **[登録]** (record).
5. Press **[ストップ]** (stop).

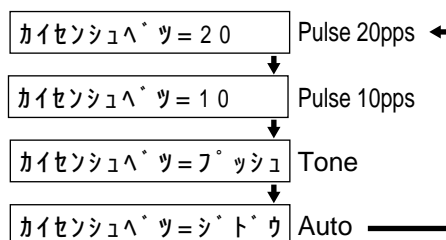

### Confirming the dial mode

1. Set the dial mode to “20”.  
(See “Changing the dial mode” shown on the left.)
2. Dial **①①⑦** (time signal).  
If you cannot dial, change to “10”.  
If you cannot dial after changing to “10”, set to “フツシユ” (tone).

#### Note:

If this unit is connected to a PBX or used as an extension, dial the access code (eg. ①) before the time signal.

# Setting the date, time, facsimile telephone number and logo

Before using your unit, program the correct date, time, facsimile telephone number and logo. These will be printed on the top of each page transmitted from your unit.

## 1 Setting the date and time

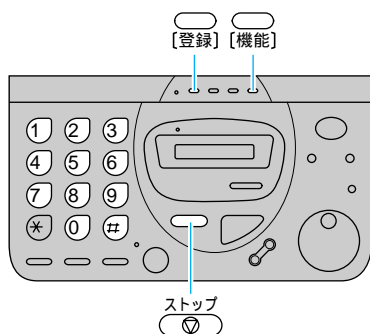

1. Press [機能] (function).
2. Press # 0 0 1 .
3. Enter the correct year/month/day/ hour/minute by selecting each 2 digits.  
Example: Aug. 10 1997 3:05PM  
Press 9 7 0 8 1 0 1 5 0 5 .
4. Press [登録] (record).
5. Press [ストップ] (stop).

## 2 Setting your facsimile telephone number

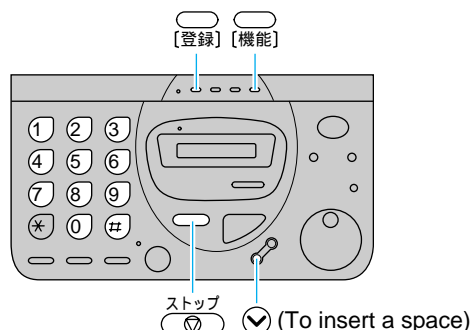

1. Press [機能] (function).
2. Press # 0 0 4 .
3. Enter your facsimile telephone number up to 20 digits.  
Example: 098-765-4321  
Press 0 9 8 ✓ 7 6 5 ✓ 4 3 2 1 .
4. Press [登録] (record).
5. Press [ストップ] (stop).

## 3 Setting your logo

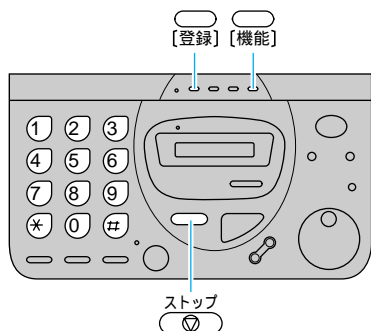

1. Press [機能] (function).
2. Press # 0 0 2 .
3. Enter your logo up to 30 characters.  
Refer to the character list.
4. Press [登録] (record).
5. Press [ストップ] (stop).

Character List

	Number of times																	
	1	2	3	4	5	6	7	8	9	10	11	12	13	14	15	16	17	18
①	ア	イ	ウ	エ	オ	ァ	ィ	ゥ	ェ	ォ	1							
②	カ	キ	ク	ケ	コ	A	B	C	a	b	c	2						
③	サ	シ	ス	セ	ソ	D	E	F	d	e	f	3						
④	タ	チ	ツ	テ	ト	ッ	G	H	I	g	h	i	4					
⑤	ナ	ニ	ヌ	ネ	ノ	J	K	L	j	k	l	5						
⑥	ハ	ヒ	フ	ヘ	ホ	M	N	O	m	n	o	6						
⑦	マ	ミ	ム	メ	モ	P	R	S	p	r	s	7						
⑧	ヤ	ユ	ヨ	ャ	ュ	ョ	T	U	V	t	u	v	8					
⑨	ラ	リ	ル	レ	ロ	W	X	Y	w	x	y	9						
⑩	ワ	ヲ	ン	〃	°	Q	Z	q	z	0	( )	,	—	:	_	.		

Example: Bill

Press ② 7 times.

† † † I = B

Press ④ 12 times.

† † † I = B i

Press ⑤ 11 times.

† † † I = B i |

Press # 1 time.

† † † I = B i |

Press ⑤ 11 times.

† † † I = B i | |

⊗ : To move the cursor to the left

# : To move the cursor to the right

⤴ : To delete one character

✓ : To insert a space

# Telephone operation

## 1 Making/Answering voice calls

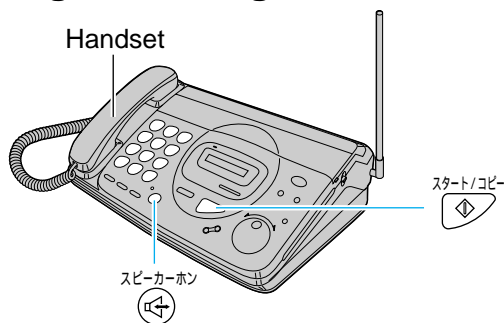

### Making calls

1. Lift the handset or press (speakerphone).
2. Dial the telephone number.
3. Talk to the other party.
4. When finished, replace the handset or press (speakerphone).

### Answering calls

1. When the phone rings, lift the handset or press (speakerphone).
2. Talk to the other party.
3. When finished, replace the handset or press (speakerphone).

#### Note:

When a slow beep or no sound is heard, press (start/copy) and replace the handset. The unit will start fax reception.

## 2 Paging the portable handset

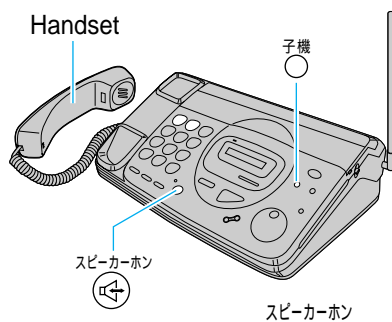

1. Lift the handset or press (speakerphone).
2. Press (portable handset). (KX-PW10CL)  
Press (portable handset) and **1** or **2**. (KX-PW10CLW)
3. Talk to the portable handset user.
4. When finished, replace the handset or press (speakerphone).

### Transferring calls to the portable handset

1. Press (portable handset) while you are talking to an outside party.  
– The portable handset is paged.
2. When the portable handset user answers, tell them a call is being transferred, then hang up.  
– The portable handset user can talk to the outside party.

#### Note:

When the portable handset user does not answer, press (portable handset) again. You can talk to the outside party.

## 3 Automatic dialing

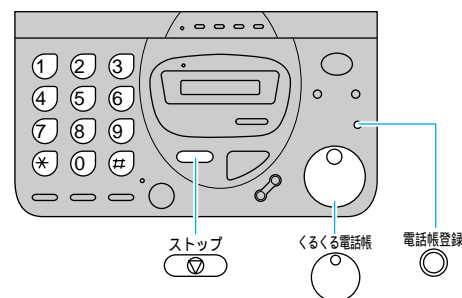

### Automatic dialing

1. Rotate (search dial) until the name you wish to dial appears on the display.
2. Lift the handset or press (speakerphone).
3. Talk to the other party.
4. When finished, replace the handset or press (speakerphone).

### Storing a phone number

1. Press (telephone directory record).
2. Enter the station name using the dialing buttons, up to 12 characters. (See "Setting your logo" on page 2.)
3. Press (telephone directory record).
4. Enter the phone number up to 30 digits.
5. Press (telephone directory record).  
– To program other stations, repeat from step 2.
6. Press (stop) when finished.

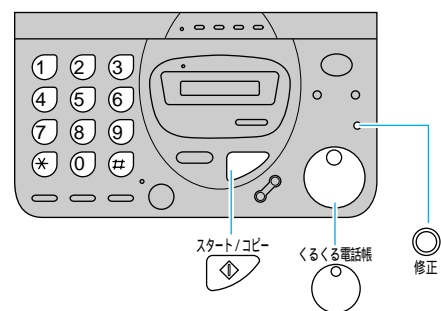

### Changing the stored name or number

1. Rotate (search dial) until the name you wish to change appears on the display.
2. Press (edit).
3. Press **\***.
4. Press **\*** or **#** to move the cursor to the incorrect character, then make the correction.
5. Press (edit).
6. Enter the correct phone number.
7. Press (edit).

### Erasing the stored name and number

Press **#** in step 3 above, then press (start/copy).

# Facsimile operation

## 1 Transmitting documents

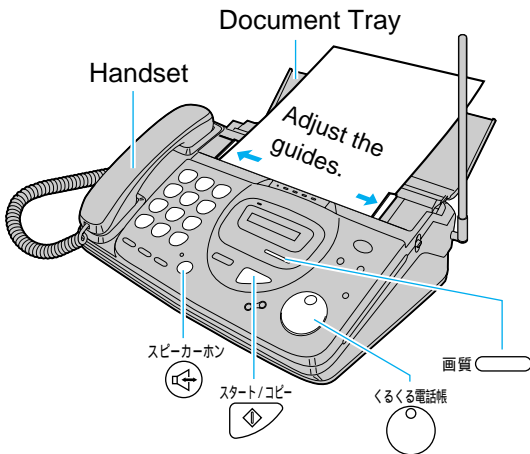

### Transmitting documents manually

1. Open the document tray and adjust the guides.
2. Insert the document FACE DOWN until a beep is heard. (5 sheets at a time)
3. Press **画質** (resolution) to select the resolution.
4. Lift the handset or press **スピーカーホン** (speakerphone).
5. Dial the phone number.
6. When a fax tone is heard, press **スタート/コピー** (start/copy).
7. Replace the handset.
  - The unit will start fax transmission.

### Selecting the resolution

Press **画質** (resolution).

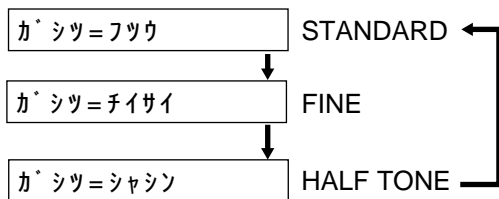

### Transmitting documents using automatic dialing

1. Open the document tray and adjust the guides.
2. Insert the document FACE DOWN until a beep is heard. (5 sheets at a time)
3. Press **画質** (resolution) to select the resolution.
4. Dial the phone number using the dial keys or select the name using **くるくる電話帳** (search dial).
5. Press **スタート/コピー** (start/copy).
  - The unit will start fax transmission.

## 2 Receiving documents

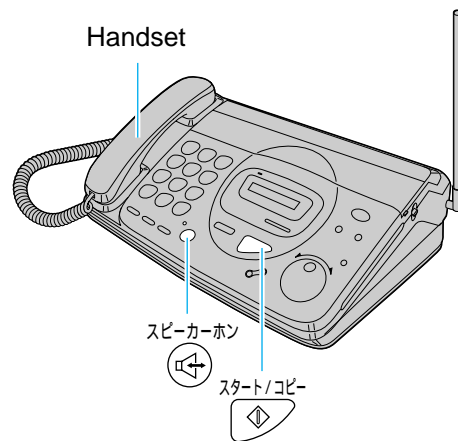

### Receiving documents manually

1. When the unit rings, lift the handset or press **スピーカーホン** (speakerphone) to answer the call.
2. When:
  - document reception is required,
  - a slow beep is heard, or
  - no sound is heard,
 press **スタート/コピー** (start/copy).
3. Replace the handset if using it.
  - The unit will start fax reception.

# Portable handset operation

## 1 Connection

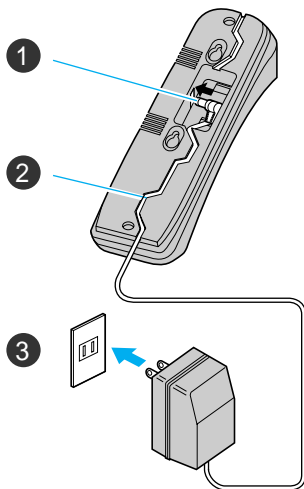

## 2 Battery installation

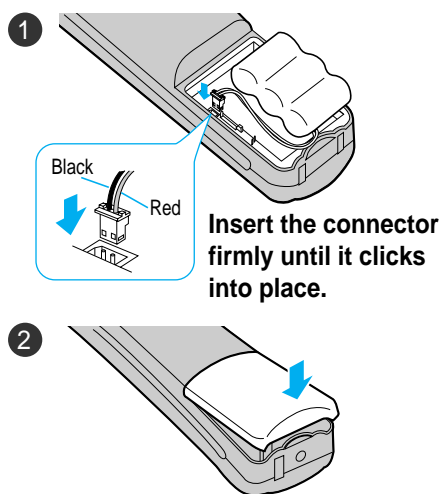

## 3 Battery charge

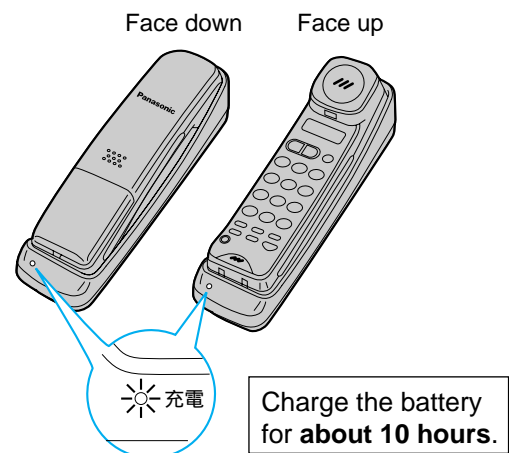

## 4 Making calls



1. Press 外線 (outside line).
2. Dial the phone number.
3. Talk to the other party.
4. Press 外線 (outside line) when finished.

## 7 Receiving fax documents

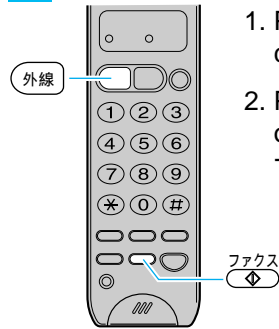

1. Press 外線 (outside line) when a call is received.
2. Press ファクス (fax) when a slow beep or no sound is heard. The main unit will start fax reception.

## 5 Answering calls



### Answering outside calls

1. Press 外線 (outside line).
2. Press 外線 (outside line) when finished.

### Answering intercom calls

1. Press 内線 (extension).
2. Press 内線 (extension) when finished.

### Answering outside calls transferred from the main unit

1. Press 内線 (extension).  
Talk with the main unit user. You can talk to the outside caller after the main unit user hangs up.
2. Press 外線 (outside line) when finished.

## 6 Paging the main unit



1. Press 内線 (extension). (KX-PW10CL)  
Press 内線 (extension) and 0. (KX-PW10CLW)
2. Talk.
3. Press 内線 (extension) when finished.

## 8 Automatic dialing

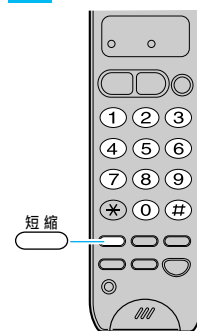

### Storing

1. Press 短縮 (store).
2. Press #.
3. Press one of the station keys (0 to 9).
4. Enter the phone number, up to 16 digits.
5. Press 短縮 (store).

### Dialing

1. Press 外線 (outside line).
2. Press 短縮 (store).
3. Press #.
4. Press one of the station keys (0 to 9).
5. Talk.
6. Press 外線 (outside line) when finished.

# Setting the receive mode

This unit has five types of receive modes. Choose the desired mode for your usage. Press  (auto receive) to switch the manual receive and auto receive modes.

## 1 Manual receive mode

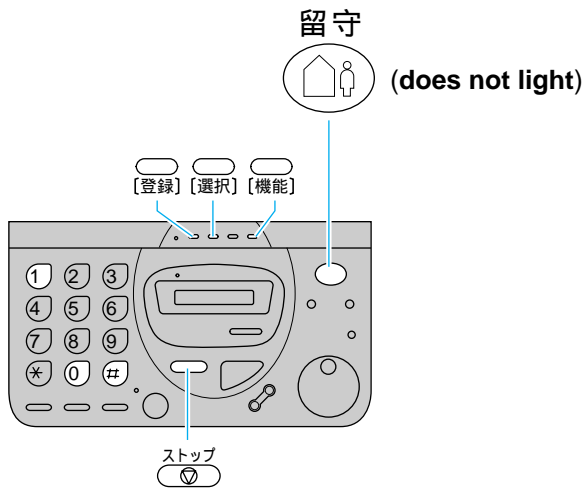









### Telephone mode (デンワユウセン)

When you wish to answer all calls manually. After answering the call, press the start button for fax reception.

### Facsimile/Telephone mode (FAXユウセン)

When you wish to answer voice calls but do not want to be disturbed by fax calls. If no one answers the call, the unit will receive the documents automatically. Or you can answer the call and press the start button for fax reception.

- Press  (function). キノウ トウロク モード
- Press    . サ イタク=テ ンユウセン  
or  
サ イタク=FAXユウセン
- Press  (select) to select the Telephone mode (テ ンユウセン) or Facsimile/Telephone mode (FAXユウセン).
- Press  (record).
- Press  (stop).

## 2 Auto receive mode

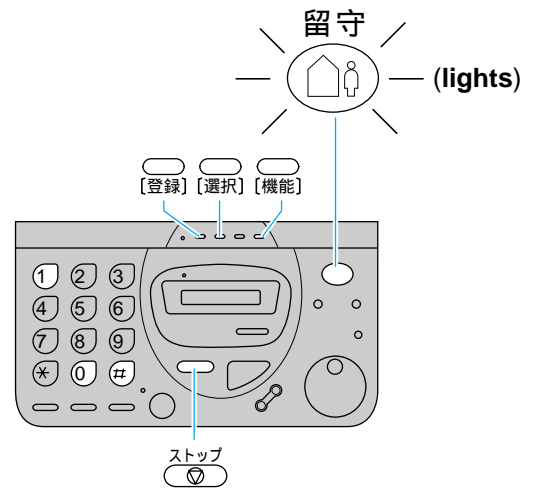

### Answering machine/Facsimile mode (FAX/ルスデン)









When you want to use the unit to record voice messages and receive documents. When a call is received, the unit plays your greeting message and records the voice message. If a fax is detected, the unit receives the documents automatically.

### Facsimile mode (FAXセンヨウ)

When you want to use the unit solely as a fax machine. The unit receives documents automatically. You can not answer voice calls and the answering device will not function.

### Answering machine mode (ルスデンセンヨウ)

When you want to use the unit to record voice messages only. The unit will not receive documents automatically.

- Press  (function). キノウ トウロク モード
- Press    . ルス=FAX/ルステ ン  
or  
ルス=FAXセンヨウ  
or  
ルス=ルステ ンセンヨウ
- Press  (select) to select the Facsimile mode (FAX/ルステ ン) or Answering machine mode (FAXセンヨウ), Answering machine/Facsimile mode (ルステ ンセンヨウ).
- Press  (record).
- Press  (stop).

# Answering device functions

## 1 Recording a greeting message

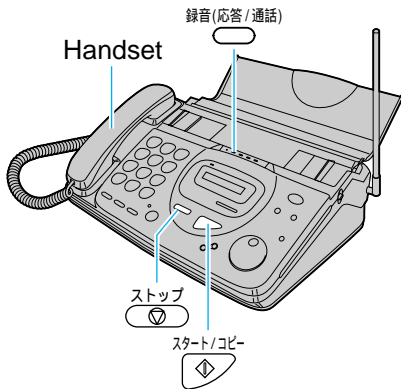

1. Press (record).
2. Lift the handset.
3. Press (start/copy).
4. Record your greeting message up to 16 seconds.
5. Press (stop) and replace the handset.
  - The greeting message will be played back once automatically.

## 2 Erasing the greeting message

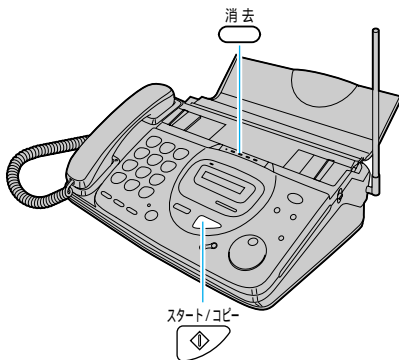

1. Press (erase) two times.
2. Press (start/copy).

## 3 Setting the automatic answering device

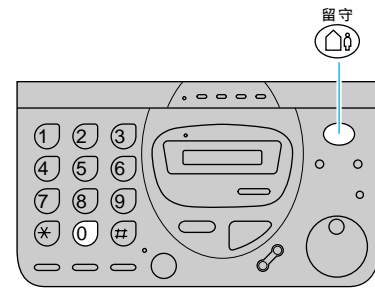

- Press (auto receive).
- The recorded voice messages which you have already listened to will be erased when new voice messages are recorded.

- If you want to save the recorded messages; Press (auto receive) while pressing .
- To cancel the automatic answering device mode, press (auto receive) again.

## 4 Listening to recorded messages

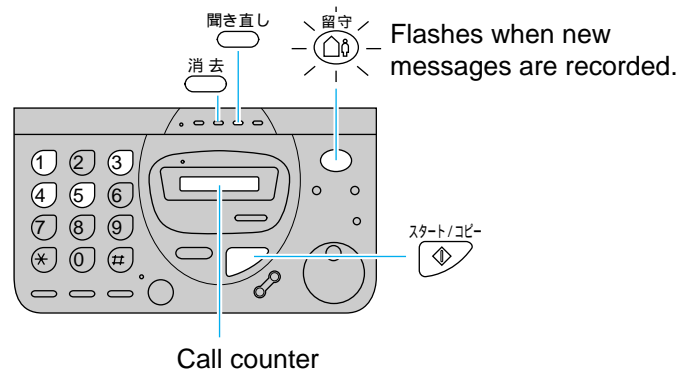

- Press (auto receive) or (repeat).

- To repeat a message during playback, press (repeat).
- To play back the previous message, press (previous).
- To change the playback speed, press (slow) or (fast).
- To skip a message, press (skip).