



Facsimile with Cordless Phone



KX-PW12CL/KX-PW12CLW
KX-PW22CLH/KX-PW22CLK
KX-PW32CL
KX-PW42CL
Model No. KX-PW52CLH

Quick Reference Guide

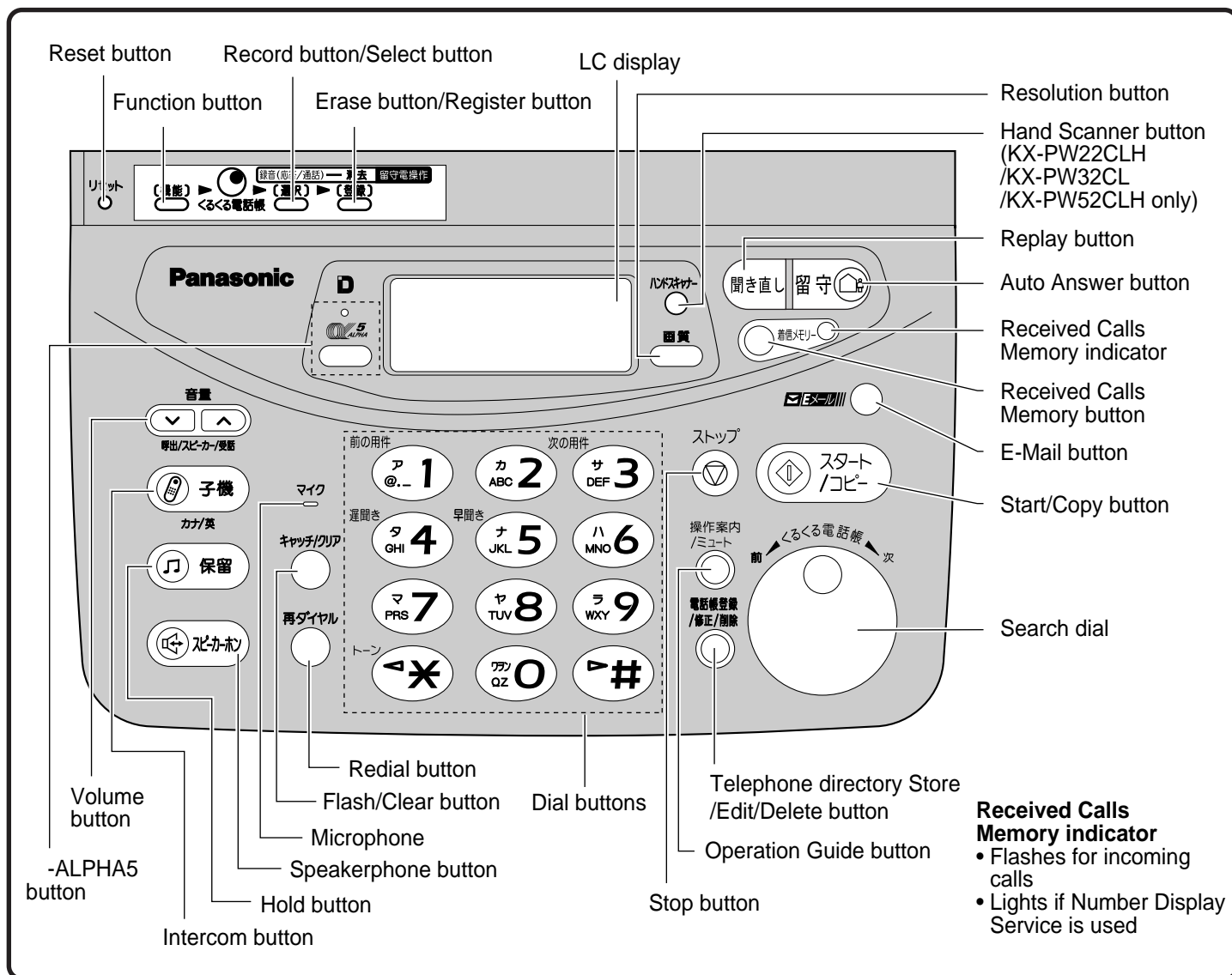

Names and Functions

HANDSET

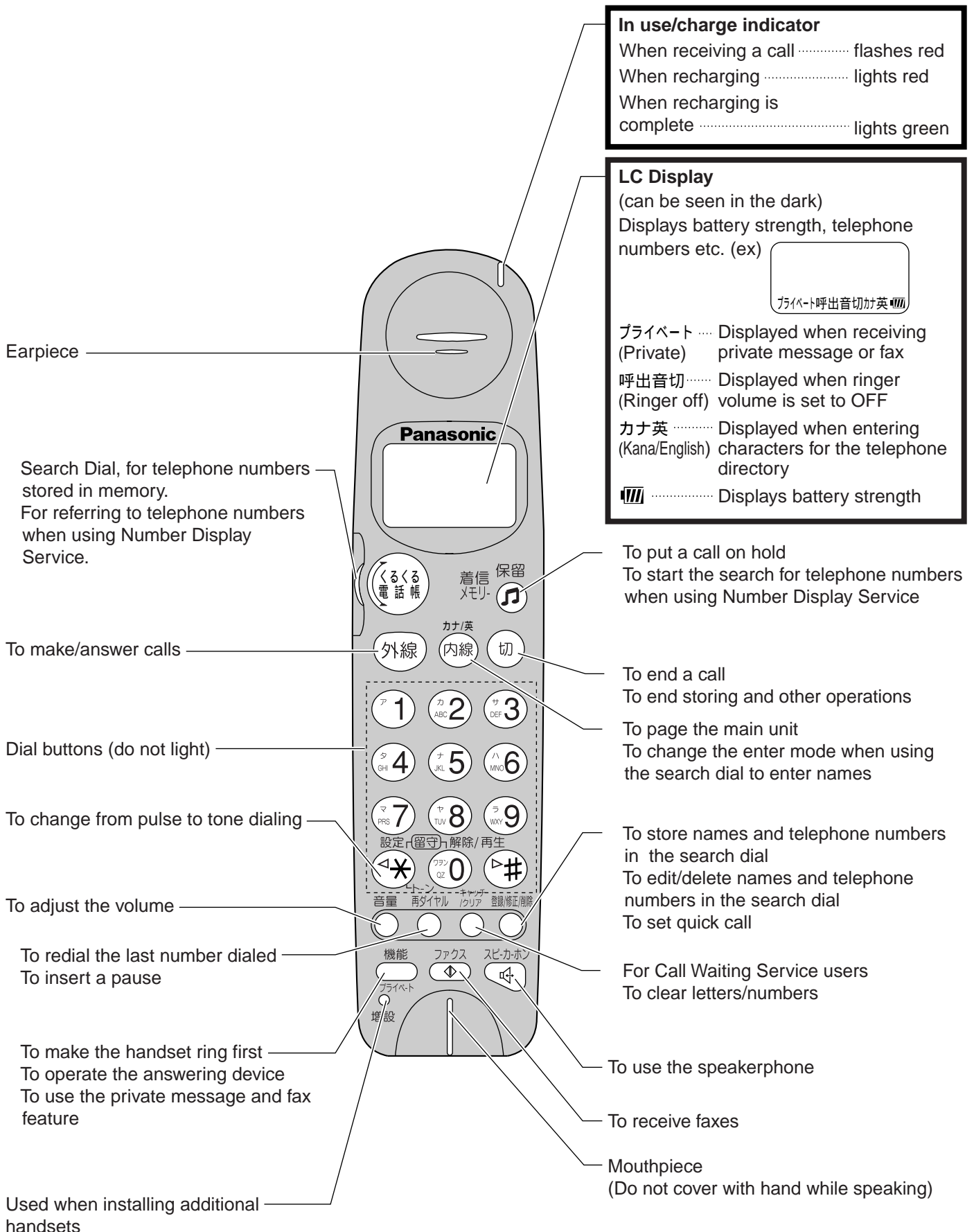

Preparations

1 Installing the recording paper (For KX-PW12CL/KX-PW22CLH /KX-PW32CL)

- ① Open the cover.

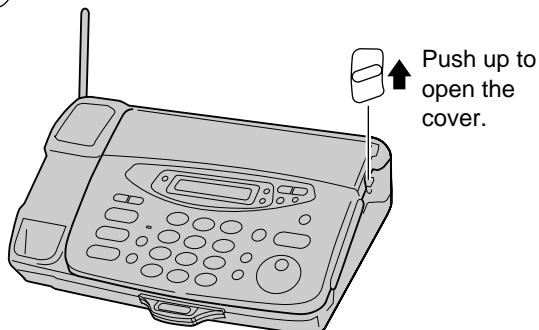

- ② Insert the thermal paper.

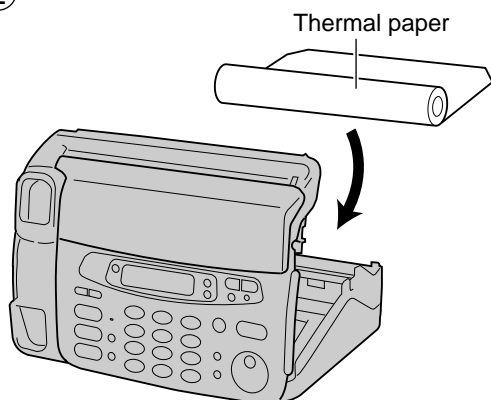

Incorrect



Slack

- ③ Close the cover.

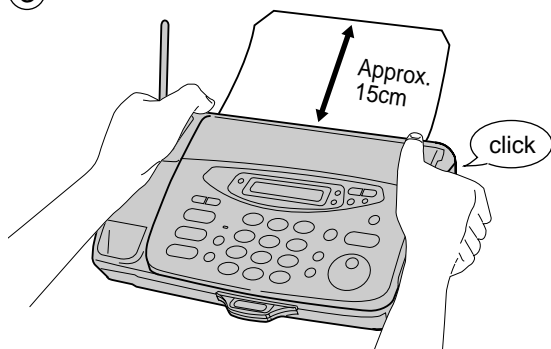

- ④ Install the stacker.

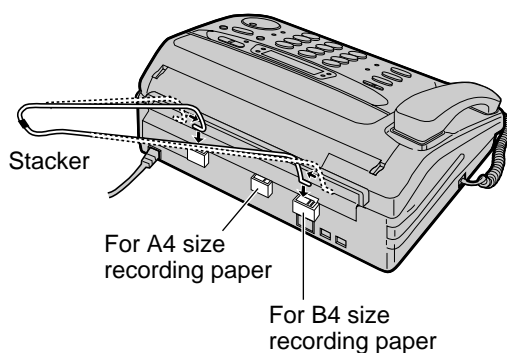

2 Installing the recording paper (For KX-PW42CL/KX-PW52CLH)

- ① Attach the recording paper sub tray to the recording paper tray.

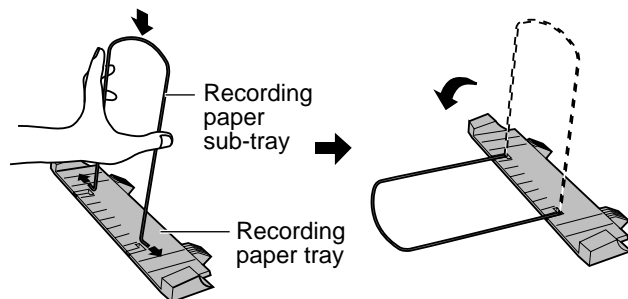

- ② Pull the recording paper cover toward the operation panel.

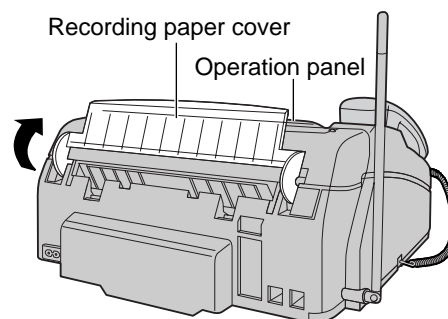

- ③ Insert the tabs of the recording paper tray into the slots.

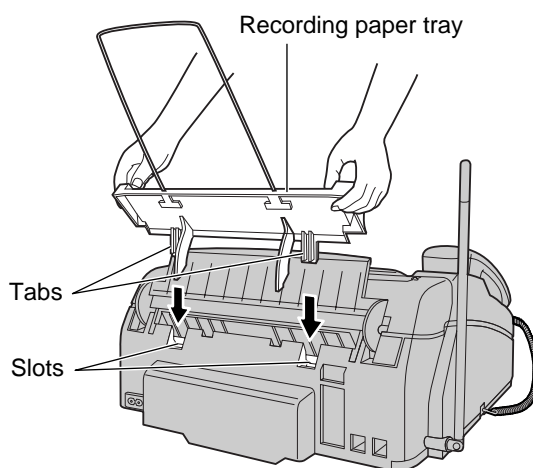

- ④ Pull the recording paper cover toward the operation panel.

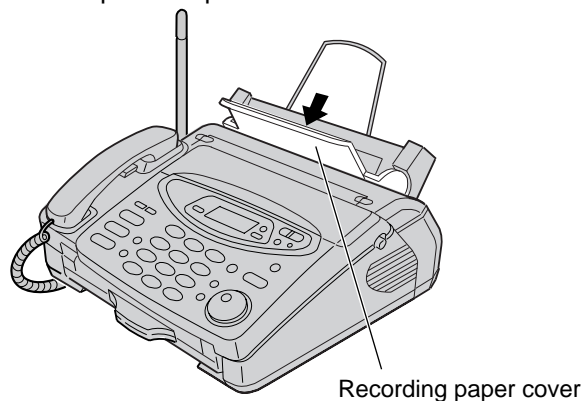

Preparations

- ⑤ Fan the paper, tap it on a level surface and then insert the paper.

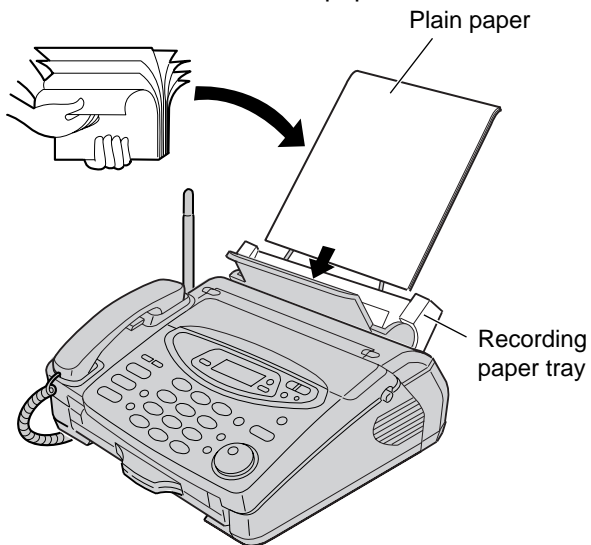

- ⑥ Return the recording paper tray to its original position.

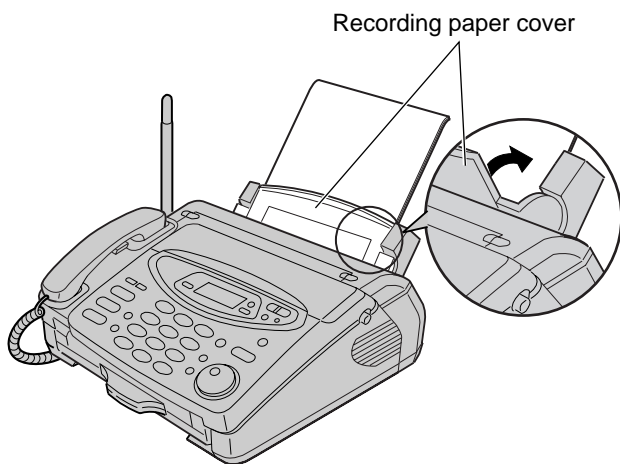

- ⑦ Insert the recording paper stacker under the cover sheet.
(KX-PW42CL/KX-PW52CLH only)

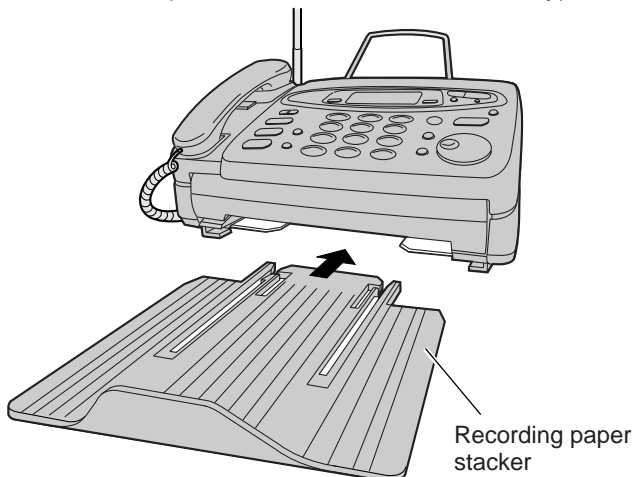

3

Connections

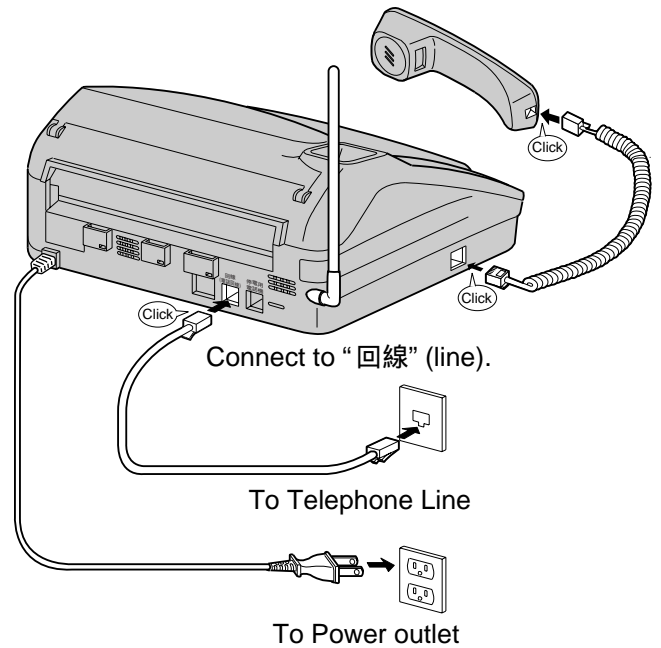

Telephone Operations

1

Making/Answering voice calls

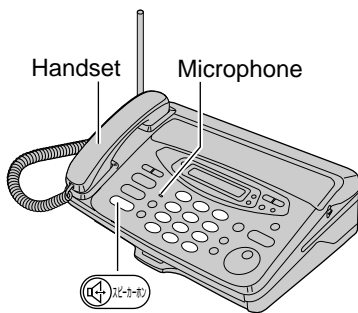

Making calls

1. Lift the handset or press (speakerphone).
2. Dial the telephone number.
3. Talk to the other party.
4. When finished, replace the handset or press (speakerphone).

Answering calls

1. When the phone rings, lift the handset or press (speakerphone).
2. Talk to the other party.
3. When finished, replace the handset or press (speakerphone).

Note:

When a slow beep or no sound is heard, press (start/copy) and replace the handset. The unit will start fax reception.

2

Automatic dialing

Main unit



Automatic dialing with the main unit

1. Rotate (search dial) until the name you want to dial appears on the display.
2. Lift the handset or press (speakerphone).
3. Talk to the other party.
4. When finished, replace the handset or press (speakerphone).

Portable handset

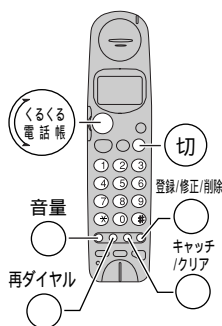

Automatic dialing with the portable handset

1. Rotate (search dial) until the name you want to dial appears on the display.
 - If the name has not been stored, press (end) and store the name, or dial the number manually.
2. Press (outside line) or (speakerphone).
 - ➔ The number will be dialed.
 - The last 12 digits (including spaces) will be displayed.
3. Talk to the other party.
4. When finished, press (end).

Storing a phone number in the main unit

1. Press (telephone directory store/edit/delete).
2. Enter the station name, up to 12 characters, using the dialing buttons.
3. Press (telephone directory store/edit/delete).
4. Enter the phone number up to 30 digits.
5. Press (telephone directory store/edit/delete).
 - To program other stations, repeat from step 2.
6. Press (telephone directory store/edit/delete). (For KX-PW12CL users: skip this step)
7. Enter the group number (1-4).
8. Press (telephone directory store/edit/delete).







Storing a phone number in the portable handset

The following 5 numbers have been pre-programmed :

- DDI Customer Center (0077-772)
- Time (117)
- Weather Information (177)
- Telegrams (115)
- Directory Assistance (104)









1. Press (store/edit/delete).
 - xx will show how many items can still be stored.
2. Use the dial buttons to enter the desired name, up to 12 characters.
 - If you do not want to store a name, go to step 3.
3. Press (store/edit/delete).

Telephone Operations

- Use the dial buttons to enter the phone number, up to 30 digits.
 - Press  (volume) to insert a space. キャッチ / クリア
 - If you enter a wrong number, press  (clear).
 - If you enter 12 or more digits (including spaces), numbers will disappear from the screen from the left.
- Press  (store/edit/delete). To enter a 2nd or 3rd number, repeat from step 4.
- Press  (store/edit/delete).
 - If you do not want to enter a group number, go to step 8. (If a group number is not entered, the numbers will be stored in group 1.)
- Enter a group number (1-4) if required.
- Press  (store/edit/delete).
 - To continue storing, repeat from step 2.
 - To end storing, press  (end).

Changing a stored name or number



- Rotate  (search dial) until the name you want to change appears on the display.
- Press  (telephone directory store/edit/delete).
- Press .
- Press  or  to move the cursor to the incorrect character, and make the correction.
- Press  (telephone directory store/edit/delete).
- Enter the correct phone number.
- Press  (telephone directory store/edit/delete).
- Press  (telephone directory store/edit/delete) repeatedly until the group number is displayed.

Example: Group number=1

ク* ル-フ° = 1
[スウジ*, トウロク]

(For KX-PW12CL users: skip this step)

- Enter the correct group number.
- Press  (telephone directory store/edit/delete).



Facsimile Operations

1

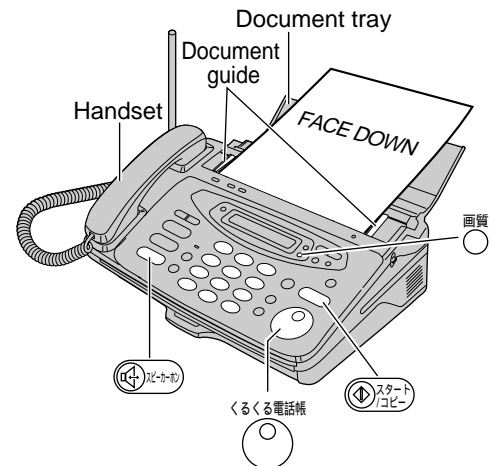
Sending documents



Sending documents manually



- Open the document tray and adjust the document guides.
- Insert the document FACE DOWN until a beep is heard. (up to 5 sheets at a time)
- Press  (resolution) to select the resolution.
- Lift the handset or press  (speakerphone).
- Dial the fax number.
- When a fax tone is heard, press  (start/copy).
- Replace the handset.
 - The unit will start fax transmission.

Selecting the resolution

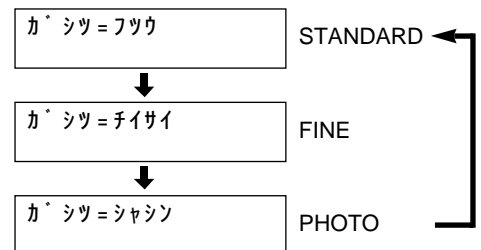
Press  (resolution).



Sending documents using automatic dialing

- Open the document tray and adjust the document guides.
- Insert the document FACE DOWN until a beep is heard. (up to 5 sheets at a time)
- Press  (resolution) to select the resolution.
- Rotate  (search dial) until the name you want to send documents to appears on the display.
- Press  (start/copy).
 - The unit will start fax transmission.

Facsimile Operations

2 Receiving documents



Receiving documents manually

1. When the unit rings, lift the handset or press (speakerphone) to answer the call.
2. When:
 - document reception is required,
 - a slow beep is heard, or
 - no sound is heard,
 press (start/copy).
3. Replace the handset if using it.
 - The unit will start fax reception.

Setting the Answer Mode

This unit has five Answer modes. Choose the desired mode according to your needs. Press (auto answer) to switch between manual answer and auto answer modes.

1 Manual answer mode

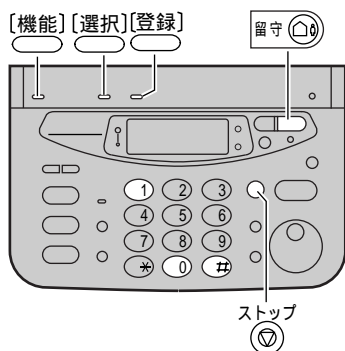

Telephone mode (デンワユウセン)

When you want to answer all calls manually. After answering the call, press the start button for fax reception.

Facsimile/Telephone mode (FAX ユウセン)

When you want to answer voice calls but do not want to be disturbed by fax calls. If no one answers the call, the unit will receive the documents automatically. Or you can answer the call and press the start button for fax reception.

Setting the Answer Mode

1. Press (function). キノウ トウロク モード
2. Press . サ イタク=FAX ユウセン
[センタク, トウロク]
OR
サ イタク=テ ンワユウセン
[センタク, トウロク]
3. Press (select) to select the Telephone mode (テ ンワユウセン) or Facsimile/Telephone mode (FAX ユウセン).
4. Press (register).
5. Press (stop).

2 Auto answer mode

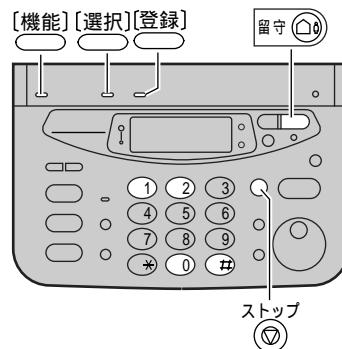

Answering machine/Facsimile mode (FAX/ルスデン)

When you want to use the unit to record voice messages and receive documents. When a call is received, the unit plays your greeting message and records the voice message. If a fax is detected, the unit receives the documents automatically.

Facsimile mode (FAX センヨウ)

When you want to use the unit solely as a fax machine. The unit receives documents automatically. You cannot answer voice calls and the answering device will not function.

Answering machine mode (ルスデンセンヨウ)

When you want to use the unit to record voice messages only. The unit will not receive documents automatically.

Setting the Answer Mode

- Press (function).
キノウ トウロク モード
- Press .
ルス=FAXセンヨウ
[センタク, トウロク]
OR
ルス=ルステ^ンセンヨウ
[センタク, トウロク]
OR
ルス=FAX/ルステ^ン
[センタク, トウロク]
- Press (select) to select the Facsimile mode (FAXセンヨウ) or Answering machine mode (ルステ^ンセンヨウ) or Answering machine/Facsimile mode (FAX/ルステ^ン).
- Press (register).
- Press (stop).
- Press (auto answer).

Answering Device Functions

1 Recording your own greeting message

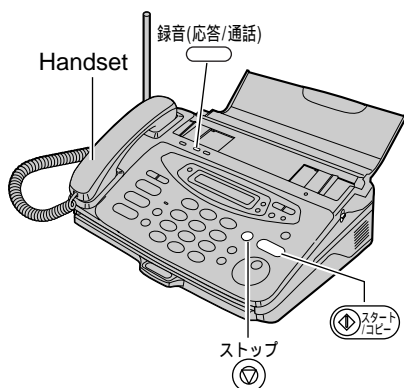

- Press (record).
- Lift the handset.
- Press (start/copy).
- Record your greeting message up to 16 seconds.
- Press (stop) and replace the handset.
– The greeting message will be played back once automatically.

2 Erasing the greeting message

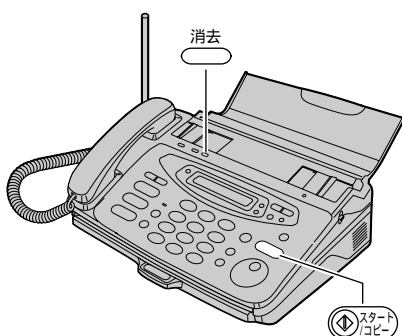

Answering Device Functions

- Press (erase) two times.
- Press (start/copy).

3 Setting up the automatic answering device

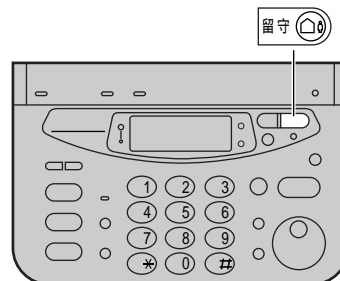

- Press (auto answer).
- To cancel the automatic answering device mode, press (auto answer) again.

4 Listening to recorded messages

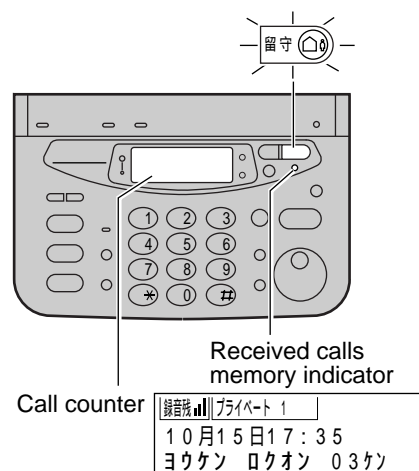

- Press (auto answer) or (repeat).

5 Erasing recorded messages

To erase all the recorded messages

- Press (erase).
- Press (start/copy).

To erase a specific message

- Press (erase) while listening to the message you want to erase.
- Press (start/copy).

Using E-mail

1

How to Subscribe

Send the enclosed “ -ALPHA5 · FAX service application form” to DDI Central Office by fax.
 FAX number: 0077-2322-9555 (24 hours)

This application form must be completed for use of -ALPHA5 (Not required if application was made at place of purchase).

How to fill in the form

Fill in your name, address and telephone number.

A monthly telephone statement is available free of charge.
 If you wish to receive the statement, circle ①. If not, circle ②.

The layout of the application form may change.

Note

- If you use NTT's dialin or double number service, register your contract number with DDI.
- **Please contact DDI Customer Service Center in the following situations**
 - If you are already using DDI
 - If you are using another telephone company (including local companies) other than NTT.
 - If you are using a discount service with NTT or another telephone company (including local companies).

2

Make sure the -ALPHA5 indicator light is green, fill in the application form and send it by fax.

1. Filling in the application form

Fill in your name. Fill in your address. Fill in your telephone number.

- Use the name of the person registered with DDI.
 The layout of the application form may change.

2. Follow the procedure for “User Registration”.

3. The unit will automatically connect to the e-mail server and transmit the necessary information for registration.

4. When communication is complete, a report, as below, will automatically be printed out.

➡ Please check that the registered telephone number is correct.

(ex)

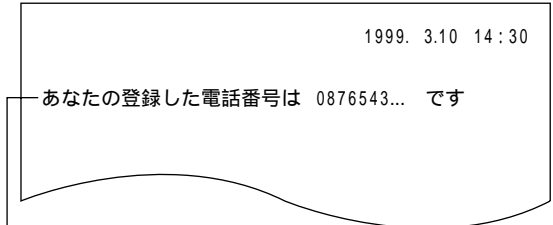

Your registered telephone number is 0876543...

3

How E-mail works

Using this unit, you can exchange E-mail with personal computer users all over the world. You can send or receive messages using the server's "mail box".

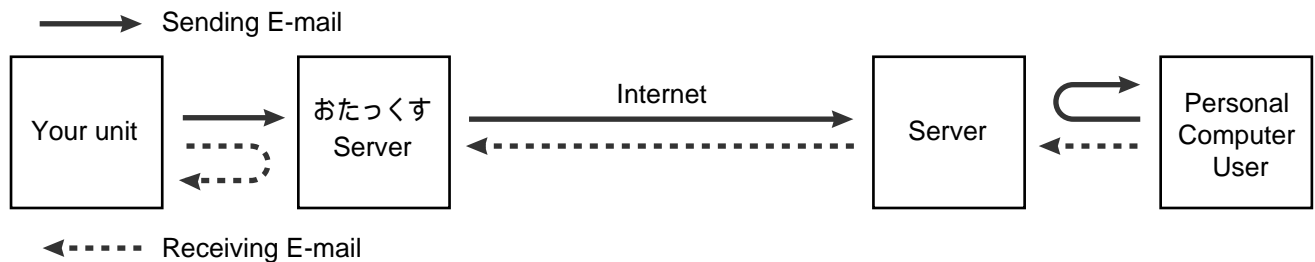

- When you register with おたっくす Information Service, the following E-mail address (example) will be supplied.

p X X X X Δ Δ Δ Δ @ fem.dion.ne.jp

User name:

Personal number
supplied by Kyushu
Matsushita Electric.

Domain name:

Common number to
おたっくす Information
Service users.

4

Before using this feature

- You have to register with DDI " -ALPHA5" and Kyushu Matsushita Electric's "おたっくす Information Service". (See "1, 2" on page 9.)

• **Charges:**

| | |
|--------------------------------|---|
| Registration fee | ¥500 (tax not included) |
| Call fee | ¥10 per 1 minute (8:00am-11:00pm) ¥8.5 per 1 minute (11:00pm-8:00am) |
| Information service fee | ¥5 per 30 seconds |

**You can do the following!
(Telephone charges and information charges applicable)**

- **Fax e-mail transmission :** You can send a fax as an e-mail message to a PC (with TIFF viewer) or おたっくす fax machine (data will be in TIFF format).
- **E-mail text transmission :** You can send e-mail messages entered using the dial buttons (data will be sent in text format).
- **E-mail reception :** You can print out e-mail messages (If there are no messages, you will only be charged for the telephone call).

- **E-mail not yet downloaded :**

You can print out information about e-mails which have not yet been downloaded (telephone call charge only).

- **Checking number of e-mails not yet downloaded :**

At pre-set intervals you can automatically connect to the server and check the number of e-mails. (You will only be charged for the telephone call. However if you receive e-mail at the same time, an information charge will be applicable.)

- **Extension functions :**

You can carry out each operation following the voice guidance. New services planned for the future.

- **Storing e-mail addresses :**

You can store frequently used e-mail addresses (no charge).
KX-PW42CLUp to 10
KX-PW52CLH . . .Up to 5

- **Storing domain names :**

You can store frequently used domain names (no charge).
KX-PW42CLUp to 5
KX-PW52CLH . . .Up to 2

5 Registering with -ALPHA5

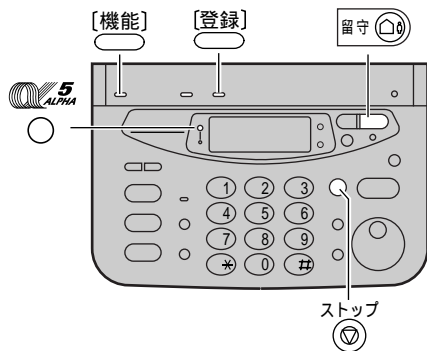

1. Fill in the “ -ALPHA5, -FAXサービス利用申込書” application form and fax it to 0077-2322-9555. (See “1” on page 9.)
2. Register your telephone number and tip code as follows.
 - a. Press [機能] (function), then press 5 ALPHA.
 - b. Enter your telephone number.
 - c. Press [登録] (register).
 - d. Enter your tip code.
 - e. Press [登録] (register).
 - f. Press ストップ (stop).
3. 1 minute later, the fax machine will automatically dial to DDI.
 - 2 or 3 weeks later, the -ALPHA5 indicator will light up green.

6 Registering at おたっくす Information Service

Make sure the -ALPHA5 indicator light is green.

1. Fill in the “おたっくす情報サービス利用申込書” application form. (See “2” on page 9.)
2. Press [機能] (function), then press E-MAIL (E-mail).
3. Press スタート/コピー (start/copy).
 - The display will show the telephone number that has been registered at -ALPHA5.
4. Press スタート/コピー (start/copy).
5. Set the application form on the fax machine.
6. Press スタート/コピー (start/copy).
7. 5 minutes later, a bell will ring and data communication will automatically start.
 - If you have another call during data communication, hang up and wait for a while.
8. After the data communication, a user registration guide will be sent from the E-mail server.
 - Please write down the E-mail address and security code sent from the server on the back cover of the operating instructions so as not to forget them.

7 Sending fax documents by E-mail

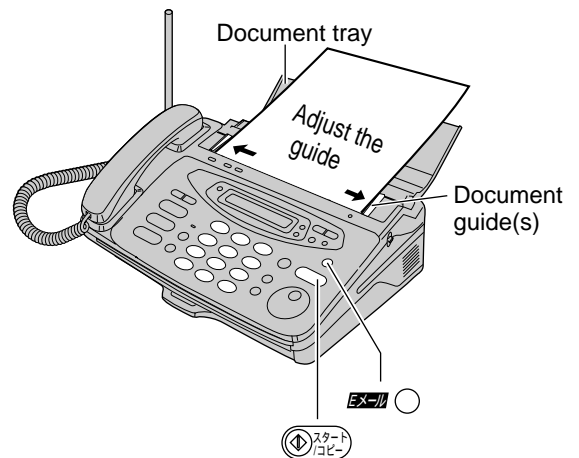







1. Open the document tray and adjust the document guides.
2. Insert the document FACE DOWN until a single beep is heard and select the resolution.
3. Press E-MAIL (E-mail).
4. Enter the required E-mail address.
 - Refer to the character list on page 13.
5. Press スタート/コピー (start/copy).
6. Enter the title (32 characters max.).
 - Refer to the character list on page 13.
7. Press スタート/コピー (start/copy).

Note:

- To send E-mail to an address stored in memory (see “8” on page 12), perform steps 1 to 3 above, then follow these steps:
 4. Rotate 設定 (setting) until the name you want to send to is displayed.
 5. Press スタート/コピー (start/copy).

8

Storing E-mail addresses

1. Press  (function).
2. Rotate  (search dial) until the message “アト` ㄥス ㄥヨウ トウロク” is displayed.
3. Press  (start/copy).
4. Enter the name up to 12 characters.
 - Refer to the character list on page 13.
5. Press  (telephone directory store/edit/delete).
6. Enter the E-mail address up to 60 characters.
 - Refer to the character list on page 13.
7. Press  (telephone directory store/edit/delete).
 - To program other E-mail addresses, repeat from step 4.
8. Press  (stop).

Note:

- For KX-PW12CL/KX-PW12CLW/KX-PW32CL/KX-PW42CL, up to 10 addresses can be stored.
For KX-PW22CLH/KX-PW22CLK/KX-PW52CLH, up to 5 addresses can be stored.

9

File formats you can receive

- JPEG • TIFF • BMP • TXT
 - ~. doc (Microsoft® Word 97 for Windows®)
 - ~. xls (Microsoft Excel 97 for Windows)
 - ~. ppt (Microsoft PowerPoint® 97 for Windows)
 - ~. pdf (Adobe® Acrobat® 3.0J)
- Microsoft, Windows and PowerPoint are registered trademarks of Microsoft Corporation in the United States and/or other countries. Adobe and Acrobat are trademarks of Adobe Systems Incorporated.

10

Receiving E-mail

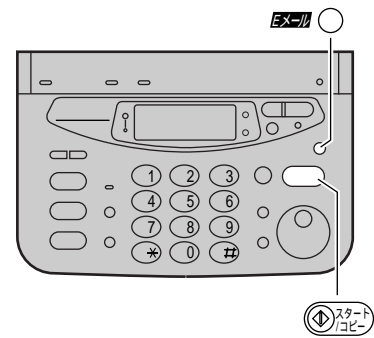

1. Press  (E-mail).
2. Press  (start/copy).

11

Character List

■ For entering a title

| Character Dial Button | Katakana | | | | | Letter | | | Numeric | Symbol | | | |
|-----------------------------|----------|---|---|-----------|------------|--------|---|---|---------|--------|---|---|---|
| ① | ア | イ | ウ | エ | オ | | | | 1 | — | & | | |
| ② | カ | キ | ク | ケ | コ | A | B | C | 2 | | | | |
| ③ | サ | シ | ス | セ | ソ | D | E | F | 3 | | | | |
| ④ | タ | チ | ツ | テ | ト | G | H | I | 4 | | | | |
| ⑤ | ナ | ニ | ヌ | ネ | ノ | J | K | L | 5 | | | | |
| ⑥ | ハ | ヒ | フ | ヘ | ホ | M | N | O | 6 | | | | |
| ⑦ | マ | ミ | ム | メ | モ | P | R | S | 7 | | | | |
| ⑧ | ヤ | ユ | ヨ | | | T | U | V | 8 | | | | |
| ⑨ | ラ | リ | ル | レ | ロ | W | X | Y | 9 | | | | |
| ⑩ | ワ | ヲ | ン | ゝ (濁点) | ゞ (半濁点) | Q | Z | | 0 | (|) | ¥ | * |
| | | | | | | | | | | # | / | ? | ! |

⊗ Button
To move the cursor to the left

Button
To move the cursor to the right

キャッチ/クリア
○ Button
To delete a character

▽ Button
To insert a space

You can also select characters by rotating
くるくる電話機

(Example : To select a character from line ②)

1 Press ②.

くるくる電話機
2 Rotate ○ to the right

カ キ ク...

くるくる電話機
Rotate ○ to the left

カ 2 C...

■ For entering an E-mail Address

| Dial Button | Number of times pressed | | | | | | | | | | | | | |
|----------------|-------------------------|---|---|---|----|---|---|---|---|----|----|----|----|----|
| | 1 | 2 | 3 | 4 | 5 | 6 | 7 | 8 | 9 | 10 | 11 | 12 | 13 | 14 |
| ① | @ | . | — | — | \$ | % | & | ~ | ^ | 1 | | | | |
| ② | a | b | c | A | B | C | 2 | | | | | | | |
| ③ | d | e | f | D | E | F | 3 | | | | | | | |
| ④ | g | h | i | G | H | I | 4 | | | | | | | |
| ⑤ | j | k | l | J | K | L | 5 | | | | | | | |
| ⑥ | m | n | o | M | N | O | 6 | | | | | | | |
| ⑦ | p | r | s | P | R | S | 7 | | | | | | | |
| ⑧ | t | u | v | T | U | V | 8 | | | | | | | |
| ⑨ | w | x | y | W | X | Y | 9 | | | | | | | |
| ⑩ | q | z | Q | Z | (|) | ¥ | ; | : | * | # | / | + | = |
| | | [|] | " | ' | ? | ! | < | > | 「 | 」 | { | } | 0 |

⊗ Button
To move the cursor to the left

Button
To move the cursor to the right

キャッチ/クリア
○ Button
To delete a character

▽ Button
To insert a space

You can also select characters by rotating
くるくる電話機

(Example : To select a character from line ②)

1 Press ②.

くるくる電話機
2 Rotate ○ to the right

a b c...

くるくる電話機
Rotate ○ to the left

a 2 C...

Specifications

■ Main unit

Power supply: AC 100 V (50 Hz/60 Hz)

| | KX-PW12CL | KX-PW22CLH | KX-PW32CL | KX-PW42CL | KX-PW52CLH |
|---------------------------|----------------|----------------|----------------|----------------|----------------|
| Power Consumption | | | | | |
| Transmission | Approx. 20 W | Approx. 20 W | Approx. 20 W | Approx. 22 W | Approx. 22 W |
| Reception | Approx. 22 W | Approx. 22 W | Approx. 22 W | Approx. 40 W | Approx. 40 W |
| Copy | Approx. 25 W | Approx. 25 W | Approx. 25 W | Approx. 36 W | Approx. 36 W |
| Standby | Approx. 3.3 W | Approx. 3.9 W | Approx. 3.3 W | Approx. 3.3 W | Approx. 3.9 W |
| Maximum*1 | Approx. 135 W | Approx. 135 W | Approx. 135 W | Approx. 140 W | Approx. 140 W |
| Dimensions (HXWXD) | 154X329X246 mm | 154X329X249 mm | 154X329X246 mm | 175X336X326 mm | 175X336X332 mm |
| Mass (Weight) | Approx. 3.5 Kg | Approx. 3.7 Kg | Approx. 3.6 Kg | Approx. 5.2 Kg | Approx. 5.4 Kg |

| | |
|----------------------------------|---|
| Operating Environment: | 5 °C–35 °C, 45 %–85 % RH (Relative Humidity) |
| Applicable Lines: | Telephone line (tone/pulse) Facsimile communication network, NCC line |
| DC Resistance*2: | 320 Ω |
| Compatibility: | G3 compatible |
| Document Size: | B4–A5 (Max. 257 mm in width, Max. 800 mm in length) |
| Effective Scanning Width: | 252 mm (B4), 208 mm (A4) |
| Effective Printing Width: | KX-PW12CL: 252 mm (B4), 206 mm (A4) KX-PW22CLH: 252 mm (B4), 206 mm (A4) KX-PW32CL: 252 mm (B4), 206 mm (A4) KX-PW42CL: 206 mm (A4 thermal paper), 202 mm (A4 plain paper) KX-PW52CLH: 206 mm (A4 thermal paper), 202 mm (A4 plain paper) |
| Transmission Time*3: | Approx. 15s/page (Original mode) |
| Modem Speed: | 9600/7200/4800/2400 bps; Automatic fallback |
| Halftone Level: | 64-level |
| Scanning Density: | Horizontal: 8 pels/mm Vertical: 7.7 lines/mm—Fine, Photo 3.85 lines/mm—Standard |
| Scanner Type: | CCD image sensor |
| Printer Type: | Thermal printing |
| Data Compression System: | Modified Huffman (MH) |
| Recording Paper Size: | KX-PW12CL: B4: 257 mm X 30 m roll A4: 210 mm X 30 m roll KX-PW22CLH: B4: 257 mm X 30 m roll A4: 210 mm X 30 m roll KX-PW32CL: B4: 257 mm X 30 m roll A4: 210 mm X 30 m roll KX-PW42CL: A4: 210 mm X 30 m roll A4: 210 mm X 297 mm plain paper KX-PW52CLH: A4: 210 mm X 30 m roll A4: 210 mm X 297 mm plain paper |
| Answering Device: | Greeting message: Digital recording system (up to 16 sec.) Pre-recorded greeting message ICM Recording: Digital recording system (approx. 12 min. in total) |
| Memory Capacity*4: | Approx. 20 pages |

*1 When copying a 100 % black document.

*2 If you cannot make a voice call due to 320 Ω of DC resistance, consult your dealer.

*3 The transmission speed is based on an A4-size document of 700 characters sent in standard resolution at 9600 bps. Transmission speed depends upon the content of the pages, resolution, telephone line conditions and capability of the receiving unit.

*4 The memory capacity is based on an A4-size document of 700 characters.

Specifications

■ Portable handset

| | |
|-------------------------------|---|
| Power Supply: | Ni-Cd battery (part no. KX-FAN37) (DC 2.4 V) (600 mAh) |
| Dimensions (HxWxD): | Approx. 190x47x40 mm |
| Mass (Weight): | Approx. 182 g (including battery) |
| Operating Environment: | 5 °C–35 °C, 45 %–85 % RH (Relative Humidity) |

■ Battery charger

| | |
|-------------------------------|---|
| Power Supply: | AC Adaptor (part no. KX-A12N, PFAP1001) AC 100 V (50 Hz/60 Hz) (DC 9 V) (200 mA) |
| Power Consumption: | Charging: Approx. 2.2 W Standby: Approx. 1.0 W |
| Dimensions (HxWxD): | Approx. 72x72x90 mm |
| Mass (Weight): | Approx. 77 g |
| Operating Environment: | 5 °C–35 °C, 45 %–85 % RH (Relative Humidity) |

■ Hand scanner (KX-PW22CLH/KX-PW32CL/KX-PW52CLH only)

| | |
|---------------------------------------|---|
| Power Supply: | KX-PW22CLH: Ni-Cd battery (part no. KX-FAN36) (DC 4.8 V) (600 mAh) KX-PW32CL: AM3/AAA/LR03 Alkaline battery (X3) or AC Adaptor (part no. KX-FAN42) AC 100 V (50 Hz/60 Hz) (DC 6 V) (540 mAh) KX-PW52CLH: Ni-Cd battery (part no. KX-FAN36) (DC 4.8 V) (600 mAh) |
| Power Consumption (KX-PW32CL): | Scanning: Approx. 2.5 W Infrared: Approx. 1.2 W Standby–Power ON: Approx. 1.0 W Standby–Power OFF: Approx. 0.7 W |
| Dimensions (HxWxD): | KX-PW22CLH: Approx. 40x275x83 mm KX-PW32CL: Approx. 30x200x50 mm KX-PW52CLH: Approx. 40x275x83 mm |
| Mass (Weight): | KX-PW22CLH: Approx. 452 g (including battery) KX-PW32CL: Approx. 195 g (including battery) KX-PW52CLH: Approx. 452 g (including battery) |
| Operating Environment: | 5 °C–35 °C, 45 %–85 % RH (Relative Humidity) |
| Effective Scanning Width: | KX-PW22CLH: 252 mm (B4) KX-PW32CL: 182 mm (B5) KX-PW52CLH: 252 mm (B4) |
| Scanning Density: | Horizontal: 8 pels/mm Vertical: 7.7 lines/mm |
| Scanner Type: | CCD image sensor |
| Memory Capacity*3: | KX-PW22CLH: Approx. 20 pages—Text (Standard) Approx. 10 pages—Text (Fine) Approx. 1 page—Photo KX-PW32CL: Approx. 60 pages—Text (Standard) Approx. 30 pages—Text (Fine) Approx. 2 page—Photo KX-PW52CLH: Approx. 20 pages—Text (Standard) Approx. 10 pages—Text (Fine) Approx. 1 page—Photo |

Copyright:

This manual is copyrighted by Kyushu Matsushita Electric Co., Ltd. (KME).
Under the copyright laws, this manual may not be reproduced in any form, in whole or part,
without the prior written consent of KME and its licensee.

© Kyushu Matsushita Electric Co., Ltd. 1999

PFQX1417ZA