

Quick Reference Guide

Facsimile

Model No. **KX-PW501DL**
KX-PW501DW



KX-PW501DL

Thank you for purchasing a Panasonic facsimile.

Table of Contents

| | |
|---|----|
| Finding the controls | 2 |
| Installations and connections | 4 |
| Setting the date and time | 7 |
| Setting your facsimile telephone number | 7 |
| Setting your logo | 8 |
| Character input and command key table | 9 |
| Automatic dialing on the main unit..... | 10 |
| Automatic dialing on the portable handset | 12 |
| Intercom between the main unit and portable handset | 14 |
| Sending faxes | 15 |
| Receiving faxes | 16 |
| Operating the built-in answering device | 17 |
| Specifications | 19 |

- This guide explains some basic features and operations, but not all of them. For further details, see the Japanese operating instructions.
- This product is designed for use in Japan.
Panasonic cannot provide service for this product if used outside Japan.
- Any details given in this guide are subject to change without notice.

Finding the controls

Main unit (control panel)

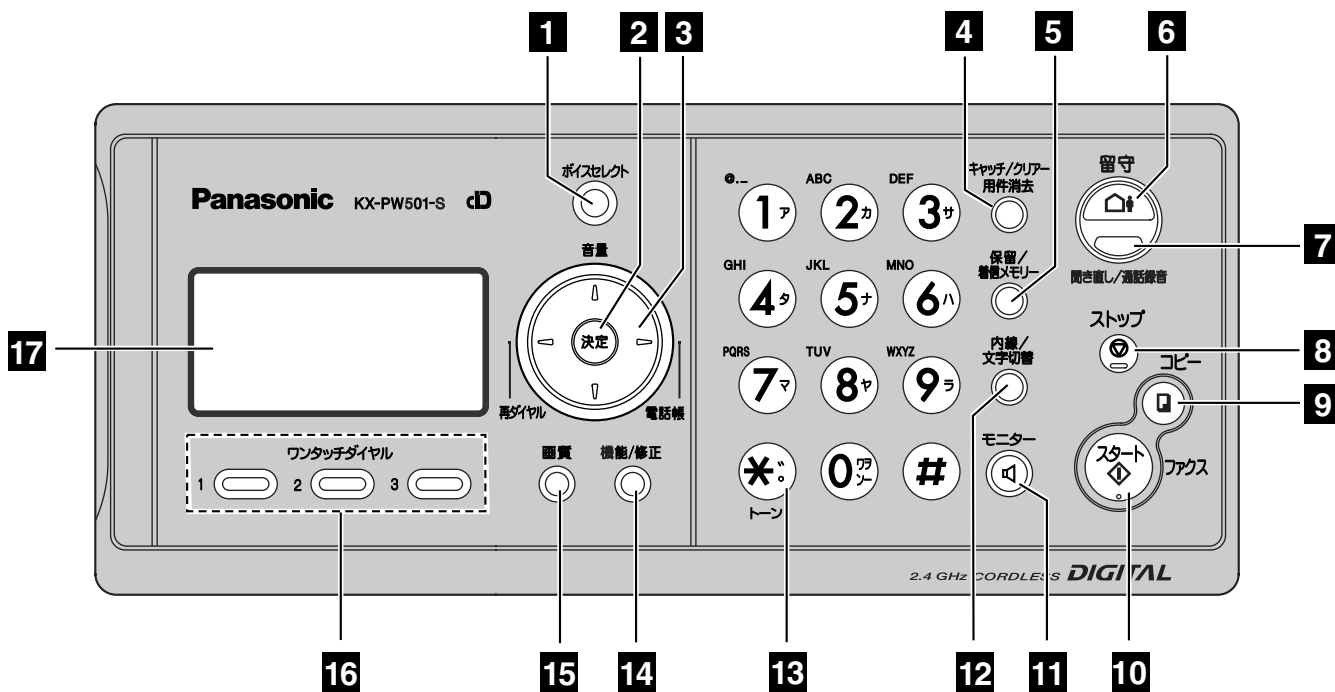

1 **Voice select** button adjusts the receiver tone quality.

2 **Set** button

3 **Volume/Redial/Phonebook** key



To adjust the volume.



To redial the phone numbers in the redial list. The last 10 phone numbers dialed are stored in memory.



To use the phonebook.

4 **Flash** button
(For call waiting service users.)

Clear button

Erase button

5 **Hold** button

Call Memory button starts a search in the Number Display log.
(For caller ID display service users.)

6 **Auto Answer** button & indicator

—light on: answering device activated.

—light off: used as a regular telephone.

Pause button

7 **Replay** button plays back recorded messages.

Record button records telephone calls.

8 **Stop** button

9 **Copy** button starts copying.

10 **Start/Fax** button starts faxing.

11 **Monitor** button

12 **Intercom/Character Input Mode** button

13 **Tone** button switches to tone dialing.

14 **Function** button initiates programming.
Edit button

15 **Resolution** button selects the resolution when faxing or copying.

16 **One-touch dial** buttons

17 **Liquid crystal display**

Finding the controls

Portable handset

How to use key

電話帳 (Telephone Book key): To use the phonebook.

再ダイヤル (Redial key): To redial the phone numbers in the redial list. The last 10 phone numbers dialed are stored in memory.

音量/変換 (Volume/Conversion key): To adjust the volume. To change Hiragana into Kanji.

外線 (External Line key): To make/answer calls.

内線 クリアー (Internal Line Clear key): To page the main unit or another portable handset. To clear letters/numbers.

切 (End Call key): To end a call. To end or exit from editing or other operations.

保留 着信メモリー (Hold/Call Memory key): To put a call on hold. To start a search in the Number Display log. (For caller ID display service users.)

Voice select button: To adjust the receiver tone quality.

キャッチ (Call Waiting key): For call waiting service users.

ワンタッチ (One-Touch key): To use the one-touch dial.

スピーカホン (Speakerphone key): To use the speakerphone.

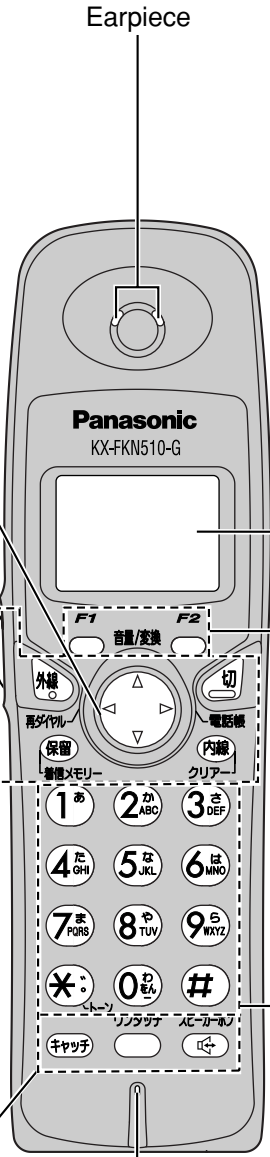

LCD (with back light)

Displays battery strength, telephone numbers etc.

① Portable handset number

② Indicates which directions the key can be tilted.

③ Out of range (Walk closer to the main unit.)

④ Battery strength

⑤ Function menu that is controlled by F1 or F2.

How to use F1 F2 buttons

F1 and F2 buttons refer to the function displayed on the bottom of the display. They function differently depending on the mode.

Dial buttons

*** トーン** (Tone button): To switch to Tone dialing mode.

(Sharp button)

Note:

If you use the portable handset near a microwave oven which is being used, noise may be heard from the earpiece or the speaker. Move away from the microwave oven and closer to the main unit.

Installations and connections

Installing the ink film

- 1** Open the control panel and the back cover.

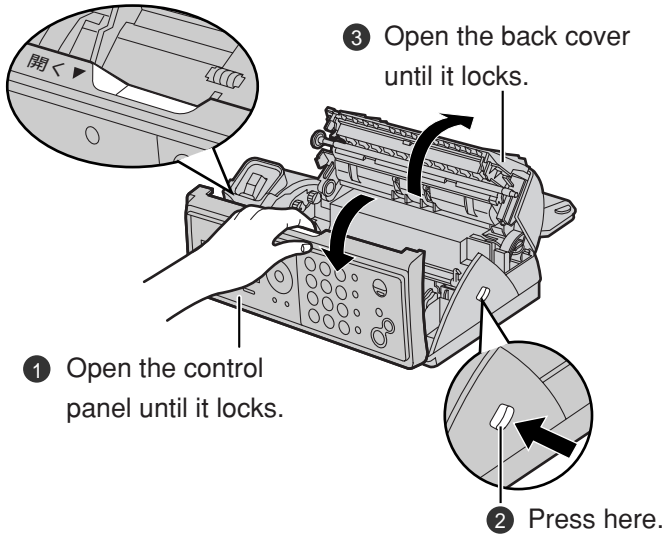

- 2** Insert the ink film.

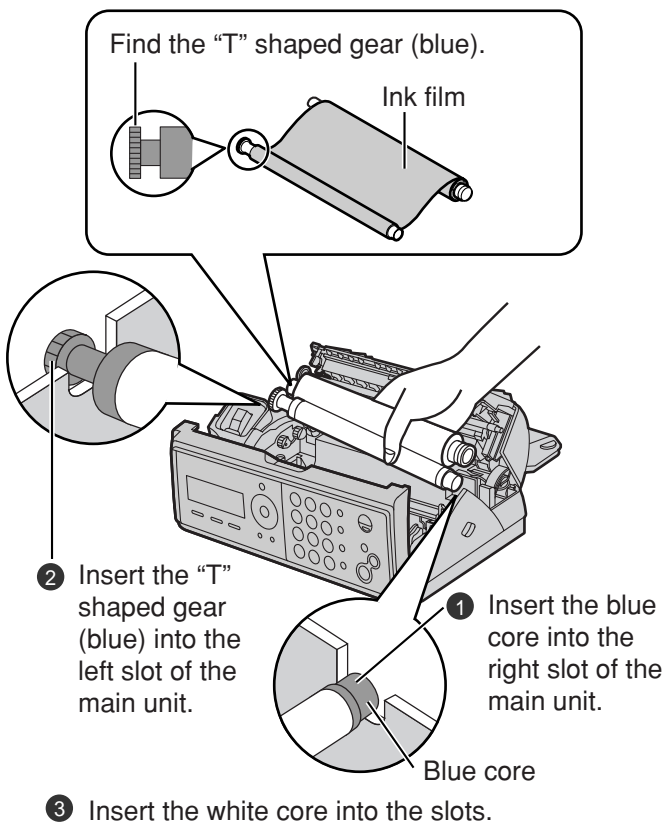

- 3** If the ink film is slack, tighten it by winding the "T" shaped gear.

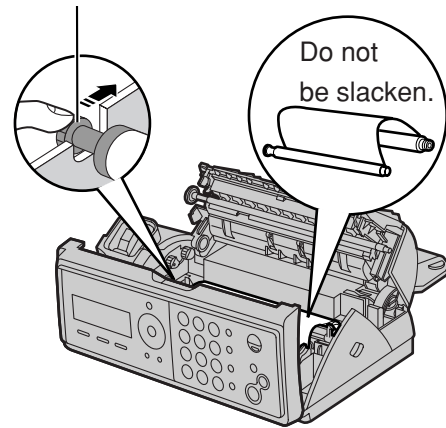

- 4** Close the back cover and the control panel until they lock.

- 1** To close the back cover, press here.

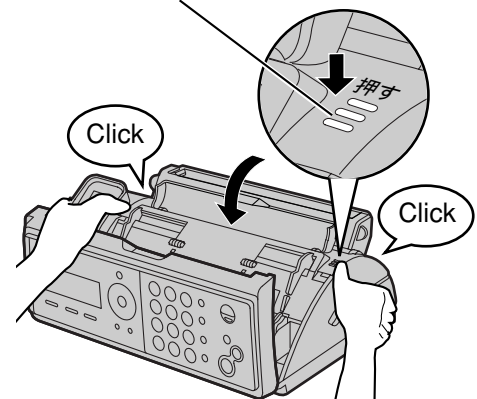

- 2** Close the control panel until it locks.

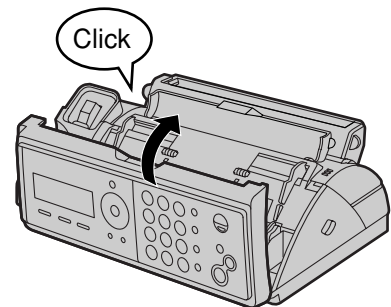

- When the unit runs out of ink film, the following message will be displayed.

フィルムガ ナナリマシタ
ヨウカンシテクタ サイ U23

フィルムガ ナナリマシタ
ヒンパ ン: KX-FAN142

Install a new ink film.

Replacement ink film:
KX-FAN142 (35 m) ¥1250

· As of December 2003.

· Tax not included.

Installations and connections

Installing recording paper (A4 size)

1 Install the recording paper tray.

- 1 Separate the recording paper cover from the recording paper tray.

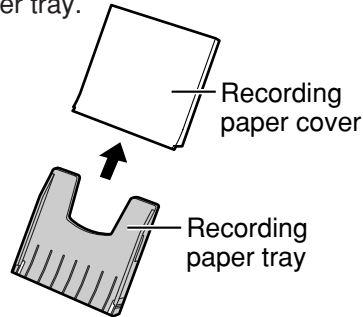

- 2 Insert the left tab on the recording paper tray into the left slot of the main unit.

- 3 Insert the right tab into the right slot of the main unit.

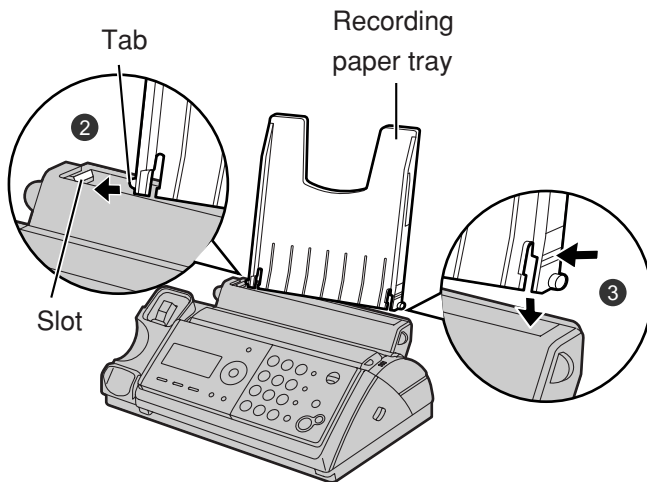

2 Insert the recording paper into the recording paper tray.

- 1 Open the paper entrance cover until it locks.

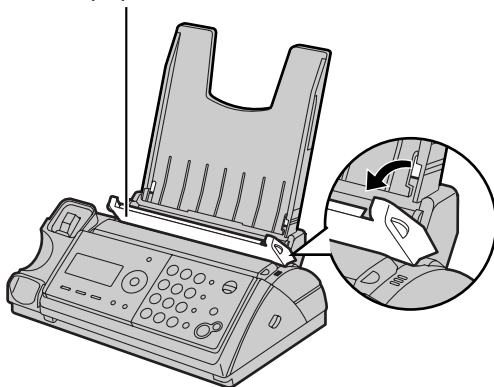

- 2 Fan the stack of recording paper (A4 size).

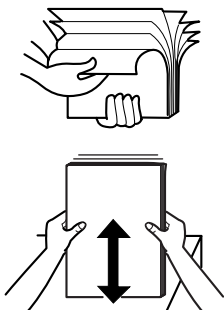

- 3 Insert the recording paper into the recording paper tray. (Up to 30 sheets)

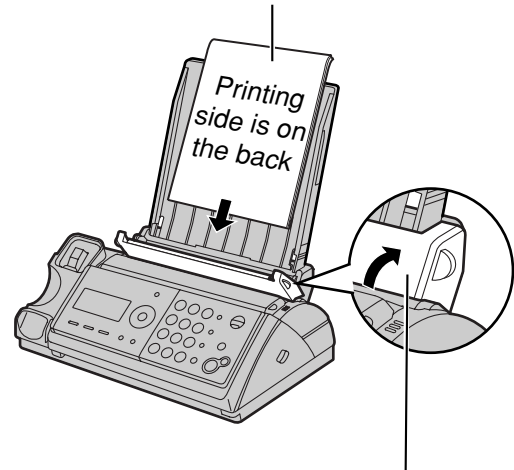

- 4 Close the paper entrance cover by leaning it back.

3 Install the recording paper cover on the recording paper tray by sliding it down from the top.

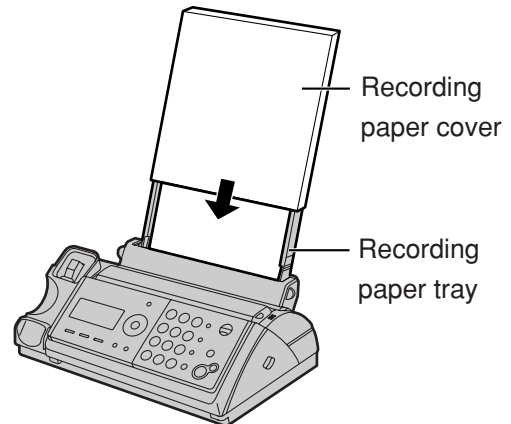

• To add paper

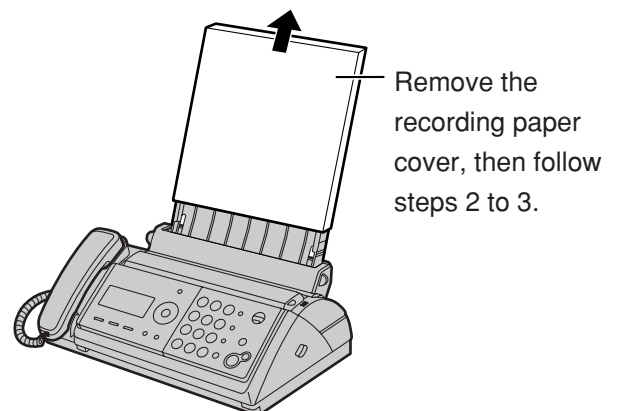

Installations and connections

Connecting the main unit

- 1 Connect the cord and place the handset on the main unit.

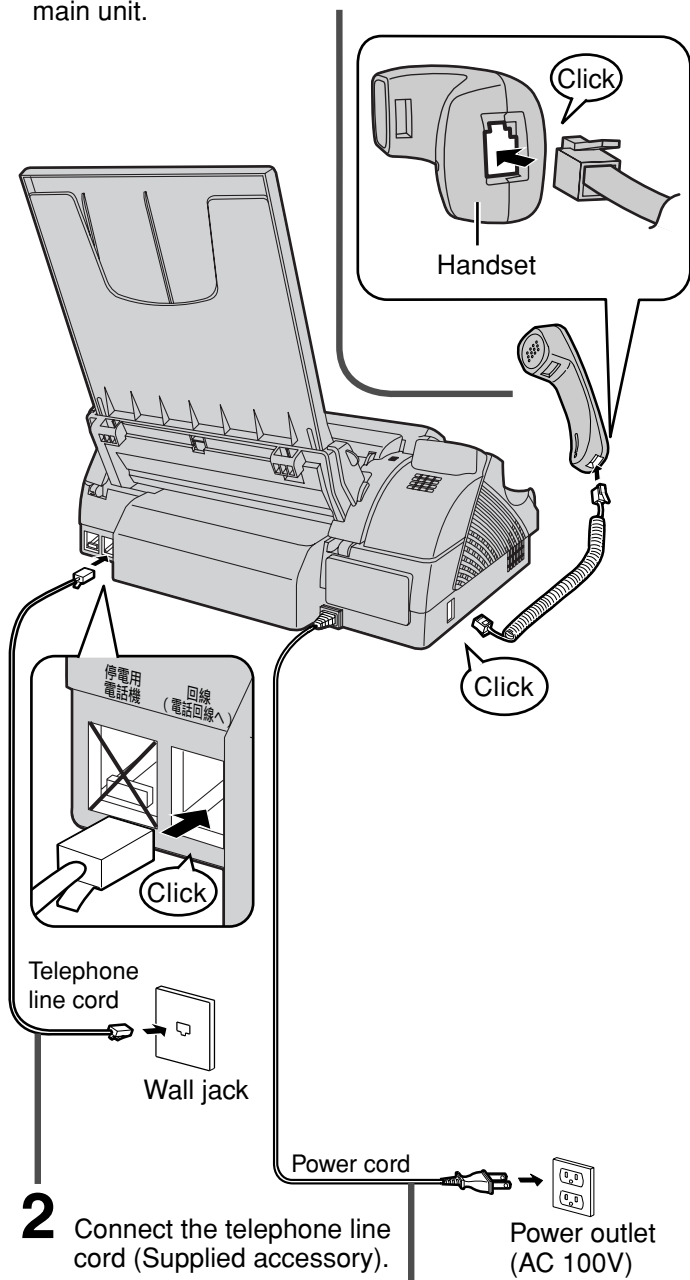

- 2 Connect the telephone line cord (Supplied accessory).

- 3 Connect the power cord.

After the Power On...

This unit will automatically select the dialing mode (Tone/Pulse).

Setting up the portable handset

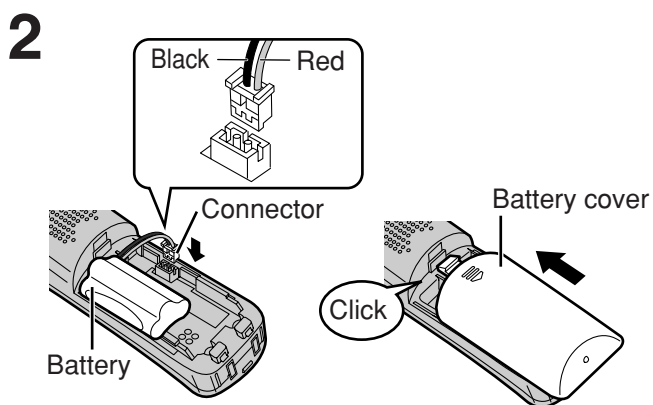
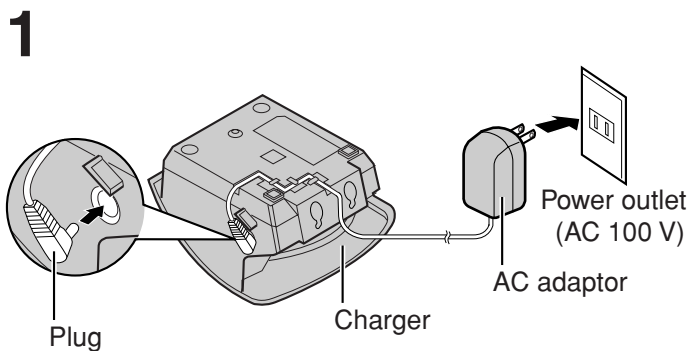

- 3 Charge the battery in the charger for 10 hours.

- After your Panasonic battery is fully charged, it will last up to about 7 hours of conversation.

- While charging.

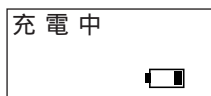

- Charging completed.

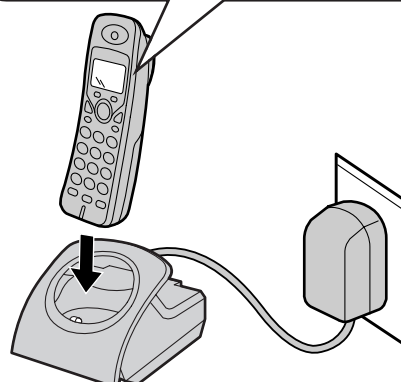
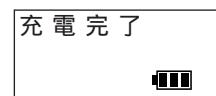

Setting the date and time

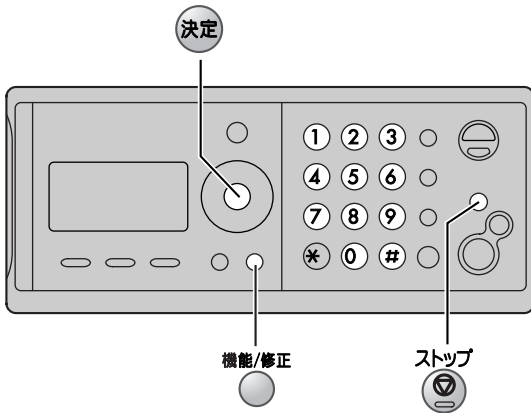

1 Press (Function/Edit).

キノウ トウロク モード
[]オス

2 Press .

Example :

| |
|-------------|
| 2004年01月01日 |
| 20:10 |

Cursor

3 Enter the correct year/month/day.
Example: October 1, 2004
Press .

2004年10月01日
20:10

4 Enter the correct hour/minute in a 24-hour clock entry.
Example: 15:45 (3:45 PM)
Press .

2004年10月01日
15:45

5 Press (Set).

トウロク シマシタ
↓
2004年10月01日
15:45

6 Press (Stop).

Example :

| |
|----------------|
| 10月 1日 15:45 |
| ヨウケン ロクオン 00ケン |

Setting your facsimile telephone number

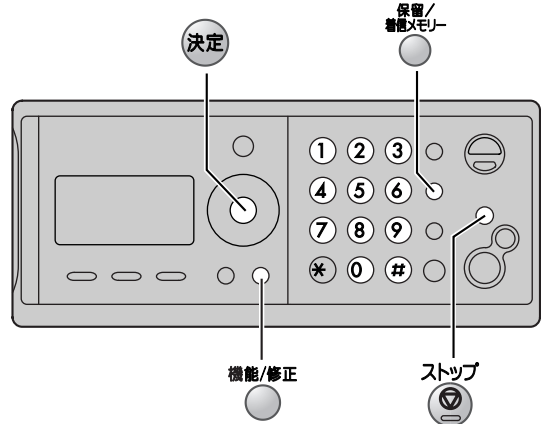

1 Press (Function/Edit).

キノウ トウロク モード
[]オス

2 Press .

アナタノテ`ンワハ`ンゴ`ウ?
TEL=[].....
Cursor

3 Enter your facsimile telephone number, up to 20 digits.
Example: 098 765 43 ..

アナタノテ`ンワハ`ンゴ`ウ?
TEL=8,765,43..

The (Space) button replaces the digit with a space.

4 Press (Set).

トウロク シマシタ
↓
アナタノテ`ンワハ`ンゴ`ウ?
TEL=098 765 43 ..

5 Press (Stop).

Example :

| |
|----------------|
| 10月 1日 15:45 |
| ヨウケン ロクオン 00ケン |

Setting your logo

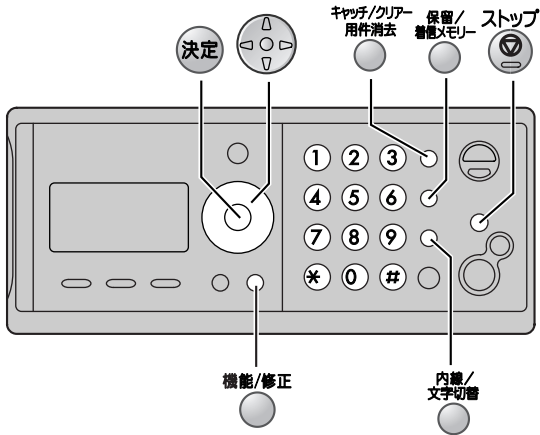

1 Press (Function/Edit).

キノウ トウロク モード
[]オス

2 Press .

アナタノナマI?
Cursor

3 Enter your logo, up to 30 characters, using the dial keypad.

- To enter English characters easily, press (Character input mode) repeatedly and select “英” (English and sign input mode).
- For details, see the table on page 9 for instructions.

Example: Micah

1. Press once.

アナタノナマI?
M
Cursor

2. Press six times.

アナタノナマI?
Mi

3. Press six times.

アナタノナマI?
Mic

4. Press to move the cursor to the next space and press four times.

アナタノナマI?
Mica

5. Press five times.

アナタノナマI?
Micah

4 Press (Set).

トウロク シマシタ
↓
アナタノナマI?
Micah









5 Press (Stop).

Example :

10月 1日 15:45
ヨウケン ロクオン 00ケン

Character input and command key table

Pressing the dial keys will select a character as shown below.

| Character | | “かな” Hiragana (For the portable handset only) | “カナ” Katakana | “英” English | “数” Numbers |
|----------------|-----------------------|---|--|--|----------------|
| (Main unit) | (Portable handset) | | | | |
| ① | ① | あいうえおあいうえお | アイウエオアイウエオ | @ . _ - & \$ ¥ % + = ^ ` ^ | 1 |
| ② | ② | かきくけこ | カキクケコ | A B C a b c | 2 |
| ③ | ③ | さしすせそ | サシスセソ | D E F d e f | 3 |
| ④ | ④ | たちつてとっ | タチツテトツ | G H I g h i | 4 |
| ⑤ | ⑤ | なにぬねの | ナニヌネノ | J K L j k l | 5 |
| ⑥ | ⑥ | はひふへほ | ハヒフヘホ | M N O m n o | 6 |
| ⑦ | ⑦ | まみむめも | マミムメモ | P Q R S p q r s | 7 |
| ⑧ | ⑧ | やゆよやゆよ | ヤユヨヤユヨ | T U V t u v | 8 |
| ⑨ | ⑨ | らりるれろ | ラリルレロ | W X Y Z w x y z | 9 |
| ⑩ | ⑩ | わをんー！？() | ワヲンー！？() | ! ? / - * # , ; : . ' ” () [] { } 「 」 | 0 |
| * | * | “ ° 、 。 | “ ° 、 。 | 、 。 | |
| Command keys | | 内線/ 文字切替  (Main unit),  (Portable handset) | Used to change the character input mode. | | |
| | |  (Main unit),  (Portable handset) | Used to move the cursor to the left and right. | | |
| | | キャッチ/クリア 用件消去  (Main unit),  (Portable handset) | Used to delete a character. | | |
| | | 保留/ 着信メモリー  (Main unit),  (Portable handset) | Used to insert a space. | | |

- The characters on the display are somewhat different from those shown in the character input and command key table.

Automatic dialing on the main unit

Storing telephone numbers in the one-touch dial

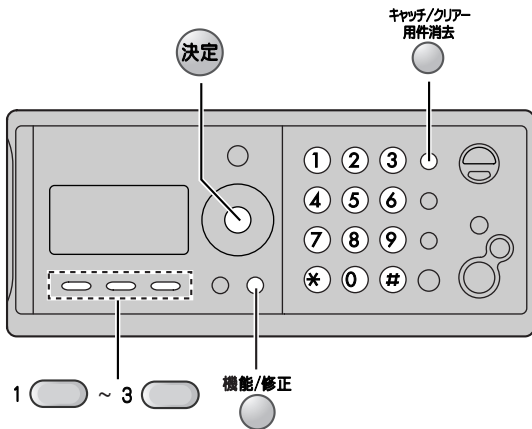

1 Press (Function/Edit).

2 Press the desired one-touch dial button (1 to 3).

Example: One-touch dial 1

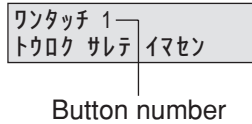

3 Enter the telephone number, up to 24 digits.

• To correct a mistake, press (Clear).

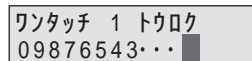

4 Press (Set).

Making a voice call using the one-touch dial

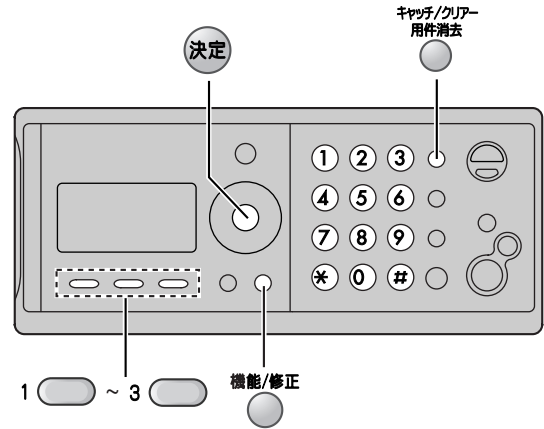

1 Press the desired one-touch dial button (1 to 3).

• The unit will start dialing.

2 When the other party answers, lift the handset.

Editing a stored number in the one-touch dial

1 Press (Function/Edit).

2 Press the desired one-touch dial button (1 to 3).

3 Edit the telephone number.

4 Press (Set).

Erasing a stored number in the one-touch dial

1 Press (Function/Edit).

2 Press the desired one-touch dial button (1 to 3).

3 Press and hold (Erase) until the telephone number has been erased.

4 Press (Set).

Automatic dialing on the main unit

Storing names and telephone numbers in the phonebook

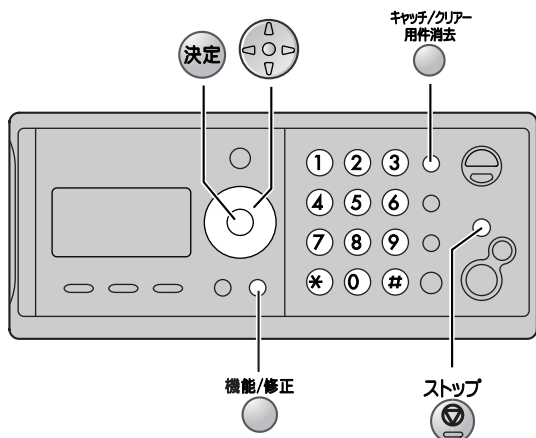

1 Press (Phonebook).

トウロク ハ [ケッテイ] オス
ケンサク ハ [] オス

2 Press (Set).

- “XXX” shows the remaining station numbers you can store.
- You can program up to 150 stations, including 4 pre-programmed stations.

テ*ンワチョウ アキ×××ケン

3 Enter the name, up to 12 characters (see the table on page 9 for instructions).

4 Press (Set).

5 Enter the telephone number, up to 24 digits.

- To correct a mistake, press (Clear).

6 Press (Set).

7 If necessary, enter the group number (1-9).

8 Press (Set).

- To program other items, repeat steps 3 to 8.

9 Press (Stop) to exit the program.

Making a voice call using the phonebook

1 Press (Phonebook).

2 Press (Search button) repeatedly until the desired name is displayed.

3 Lift the handset.

Editing a stored name or number in the phonebook

1 Press (Phonebook).

2 Press (Search button) repeatedly until the desired name is displayed.

3 Press (Function/Edit)

4 Edit the name (see the table on page 9 for instructions).

- If you do not need to edit the name, skip to step 5.

5 Press (Set).

6 Edit the telephone number.

- If you do not need to edit the telephone number, skip to step 7.

7 Press (Set).

8 Enter the correct group number.

- If you do not need to edit the group number, skip to step 9.

9 Press (Set).

10 Press (Stop) to exit the program.

Automatic dialing on the portable handset

Storing a telephone number in the one-touch dial

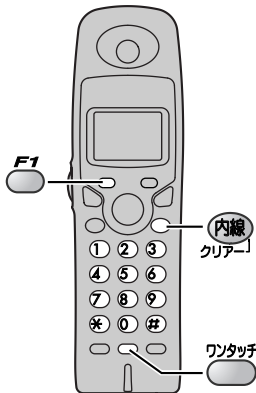

1 Press  (Function).

2 Press  (one-touch).

ワンタッチ
登録されて
いません

3 Enter the telephone number, up to 24 digits.

- To correct a mistake, press  (Clear).

ワンタッチ登録
09876543...

4 Press  (Register).

Making a voice call using the one-touch dial

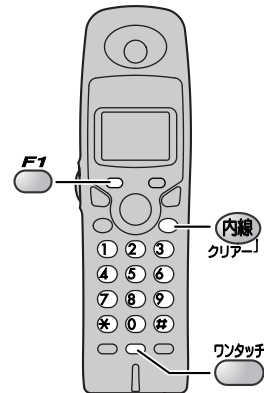

1 Press  (one-touch).
• The unit will start dialing.

2 When the other party answers, start talking.

Editing a stored number in the one-touch dial

1 Press  (Function).

2 Press  (one-touch).

3 Edit the telephone number.

4 Press  (Register).

Erasing a stored number in the one-touch dial

1 Press  (Function).

2 Press  (one-touch).

3 Press and hold  (Erase) until the telephone number has been erased.

4 Press  (Register).

Automatic dialing on the portable handset

Storing names and telephone numbers in the phonebook

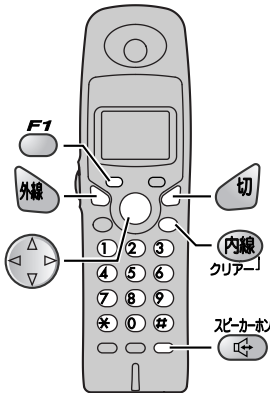

1 Press (Phonebook).

検索は
[▼▲]を押す

2 Press (Register).

- “XXX” shows the remaining station numbers you can store.
- You can program up to 150 stations, including 4 pre-programmed stations.

名前？
空き x x x 件

3 Enter the name, up to 20 characters (see the table on page 9 for instructions).

4 Press (Register) twice.

5 Enter the telephone number, up to 24 digits.

- To correct a mistake, press (Clear).

6 Press (Register).

7 If necessary, enter the group number (1-9).

8 Press (Register).

- To program other items, repeat steps 3 to 8.

9 Press (Off) to exit the program.

Making a voice call using the phonebook

1 Press (Phonebook).

2 Press (Search button) repeatedly until the desired name is displayed.

3 Press (Talk) or press (Speakerphone).

Editing a stored name or number in the phonebook

1 Press (Phonebook).

2 Press (Search button) repeatedly until the desired name is displayed.

3 Press (Edit).

4 Edit the name (see the table on page 9 for instructions).

- If you do not need to edit the name, skip to step 5.

5 Press (Register).

6 Edit the kana.

- If you do not need to edit the kana, skip to step 7.

7 Press (Register).

8 Edit the telephone number.

- If you do not need to edit the telephone number, skip to step 9.

9 Press (Register).

10 Enter the correct group number.

- If you do not need to edit the group number, skip to step 11.

11 Press (Register).

12 Press (Off) to exit the program.

Intercom between the main unit and portable handset

An intercom is available between the main unit and portable handset.

A 2-way intercom is available between 2 portable handsets.

(For KX-PW501DL users: An optional handset is needed when using this feature.)

Using the main unit:

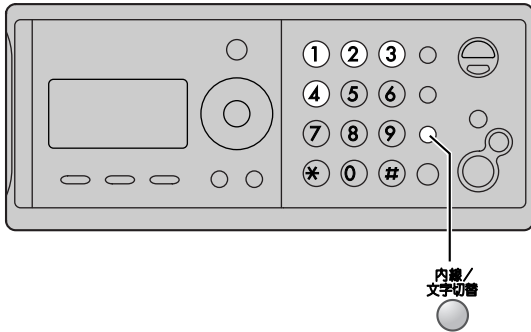

1 ■ For single portable handset users

- ① Lift the handset.

ハンコウ?

- ② Press  (Intercom).

コキ1 ヨビタシチュウ

■ For multiple portable handset users

- ① Lift the handset.

- ② Press  (Intercom).

- ③ Press the portable handset number (① to ④) which you want to call.

ナイセン ハンコウ
[12....]オス

2 Start talking.

コキ1 ナイセンツウワ チュウ

3 Replace the handset to end the intercom call.

Using the portable handset:



1 ■ For single portable handset users

Press  (Intercom).

■ For multiple portable handset users

Press , then press .

Intercom between portable handsets:

Press , then press the portable handset number (① to ④) which you want to call.

2 Start talking.

- You can switch to the speakerphone by pressing

 (Speakerphone).



内線通話中 

3 Press (Off) to end the intercom call.

Sending faxes

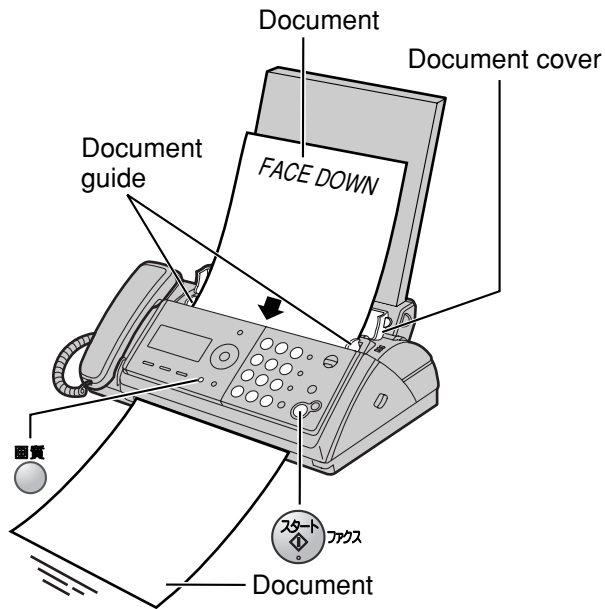
Sending a fax manually





- 1** Open the document cover, and adjust the width of the document guides to the size of the document.
- 2** Insert the document (up to 5 pages) FACE DOWN until a single beep is heard.
- 3** If necessary, press  (Resolution) repeatedly to select the desired setting (see below).
- 4** Dial the fax number.
- 5** Press  (Fax).
 - The unit will start fax transmission.

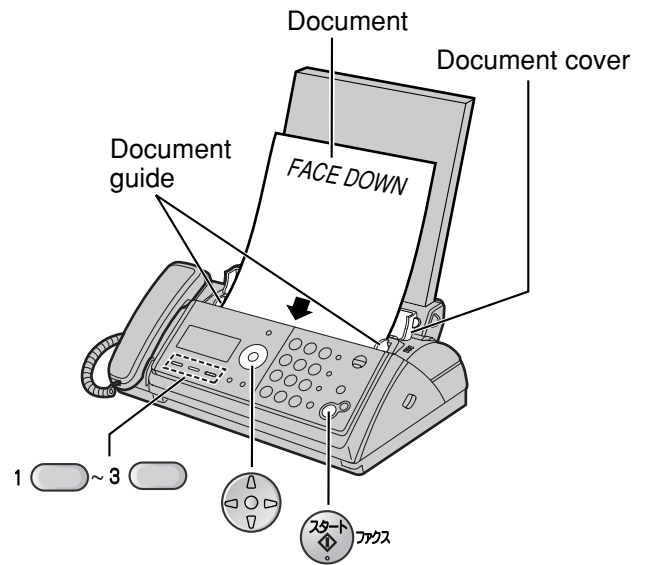

Sending a fax using automatic dialing



Using the one-touch dial

- 1** Insert the document (up to 5 pages) FACE DOWN until a single beep is heard.
- 2** Press the desired one-touch dial button (1  to 3 ).
 - The unit will start fax transmission.

Using the phonebook

- 1** Insert the document (up to 5 pages) FACE DOWN until a single beep is heard.
- 2** Press  (Phonebook).
- 3** Press  (Search button) repeatedly until the desired name is displayed.
- 4** Press  (Fax).
 - The unit will start fax transmission.

To select the resolution

Select the desired resolution according to the type of document, by pressing  (Resolution).

- | | |
|------------|---|
| カ* シツ=フツウ | (Standard) for printed or typewritten originals with normal-sized characters. |
| カ* シツ=チイサイ | (Fine) for originals with minute printing. |
| カ* シツ=シャシン | (Photo) for originals containing photographs. |

Receiving faxes

Receiving a fax manually (AUTO ANSWER off)

Using the main unit:

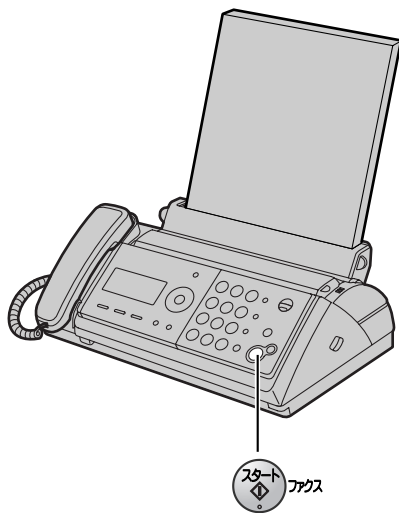

1 When you hear a ring, lift the handset to answer the call.

2 When:

- document reception is required,
- a fax calling tone (slow beep) is heard, or
- no sound is heard,

press  (Fax), then replace the handset.

- The unit will start fax reception.

Using the portable handset:

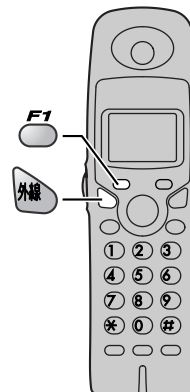

1 When you hear a ring, lift the portable handset from the charger to answer the call.

- If the portable handset is not set on the charger, press  (Talk).

2 When:

- document reception is required,
- a fax calling tone (slow beep) is heard, or
- no sound is heard,



press  (Fax reception) until a single beep is heard.

- The main unit will start fax reception.

Receiving faxes

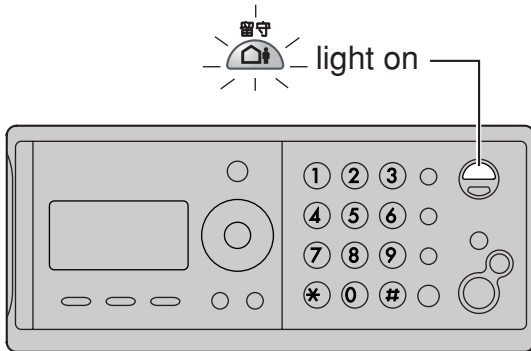
Receiving a fax automatically (AUTO ANSWER on)



1 If the  (Auto answer) light is off, turn it on by pressing .

2 When receiving a call, the unit will receive a fax document or record a voice message automatically depending on the caller's request.

Operating the built-in answering device

Recording your own greeting message

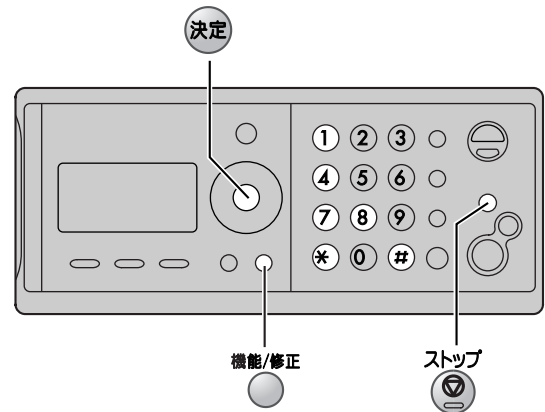

You can record your own greeting message. When receiving a call, it will be played to callers instead of the pre-recorded Japanese greeting message.

1 Press  (Function/Edit).

2 Press    .

ジ サク オウトウ ロクオン
[ケッテイ] オス

3 Press  (Set).

4 Lift the handset.

5 Press  (Set) and speak your greeting message, up to 16 seconds, to the handset.

6 Press  (Stop) and replace the handset.

- Your greeting message will be played back automatically.

Erasing your own greeting message

1 Press  (Function/Edit).

2 Press    .

ジ サク オウトウ ショウキョ
[ケッテイ] オス

3 Press  (Set).

4 Press .

- The pre-recorded Japanese greeting message will be played when you receive a call.

Operating the built-in answering device

Activating the answering device

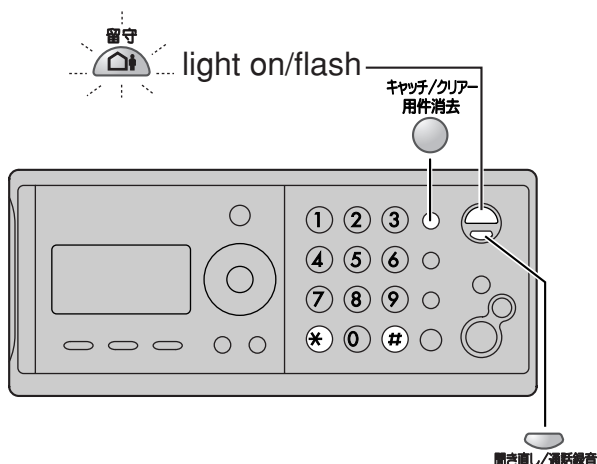

- 1 Turn the (Auto answer) light on by pressing .
- 2 When receiving a call, a greeting message will be played and the unit will record a voice message.
 - To record your own greeting message, see page 17.

Listening to recorded messages

When new messages are recorded, the (Auto answer) light will flash.

Press to listen to recorded messages.

After the messages are played back, the following will be displayed.

- To erase the messages, press .
- To save the messages, press .

サイセイシタヨウケンショウキヨ
スル=* シナイ=#

Listening to all of the recorded messages

Press (Replay/Record).

After the messages are played back, the following will be displayed.

- To erase the messages, press .
- To save the messages, press .

サイセイシタヨウケンショウキヨ
スル=* シナイ=#

Erasing a specific message

Press (Erase) while listening to the message you want to erase, then press .

Erasing all of the recorded messages

- 1 Press (Erase).

- 2 Press .

スヘ テ ショウキヨシマスカ?
ハイ=* イイエ=#

Operating the answering device from a remote location

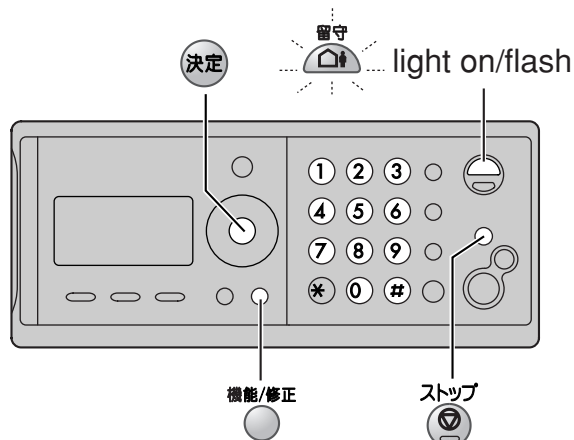

Preparation: Programming the remote operation ID

1. Press (Function/Edit).
2. Press .
3. Enter any 4-digit number (remote operation ID).
 - * and # cannot be used.

Example :

アソシヨウ No. = 1234
[4ケタ, トウロク] オス

4. Press (Set).
5. Press (Stop) to exit the program.

Operation: Listening to a recorded message from a remote location

Turn the (Auto answer) light on before you go out. Remote operations are available only from a touch tone telephone.

1. Call your unit.
2. Enter the remote operation ID during the greeting message.
3. Press or wait 4 seconds.
 - Only the new recorded messages will be played back.
 - To listen to all the recorded messages, press after the new messages have been played back.

Specifications

| KX-PW501DL KX-PW501DW | Main unit | Portable handset | Battery charger |
|-------------------------------|---|---|--|
| Power supply | AC 100 V (50 Hz/60 Hz) | Ni-MH battery (Part no. KX-FAN50) DC 3.6 V, 600 mAh | AC adaptor (Part no. PFAP1009) AC 100 V (50 Hz/60 Hz) DC 7.5 V, 100 mA |
| Frequency | 2.4 GHz | | |
| Power consumption | Transmission: Approx. 16 W Reception: Approx. 22 W Copy: Approx. 20 W Stand by: Approx. 1.0 W (When the F-net service is not in use.) Maximum(*1): Approx. 130 W | | <ul style="list-style-type: none"> • Charging: Approx. 1.5 W • Stand by: Approx. 0.6 W |
| Dimensions (H x W x D) | Approx. 140 X 331 X 237 mm (without projections) Approx. 365 X 331 X 268 mm (recording paper tray installed, without projections) | Approx. 161 X 47 X 39 mm | Approx. 64 X 80 X 90 mm |
| Mass (Weight) | Approx. 3.5 kg (10 m ink film installed) | Approx. 140 g (battery installed) | Approx. 80 g |
| Operating environment | 5 °C – 35 °C, 45 % – 85 % RH (Relative Humidity) | | |

| KX-PW501DL KX-PW501DW | Main unit |
|--------------------------------|--|
| Applicable line | Public Switched Telephone Network (Tone/Pulse), F-Net, NCC Lines |
| DC resistance | 320 Ω (*2) |
| Compatibility | G3 compatible |
| Document size | A4-A5 (Max.216 mm in width, Max. 600 mm in length) |
| Effective scanning size | 208 mm (A4) |
| Effective printing size | 202 mm (A4 size plain paper) |
| Transmission time | Approx. 15 s/page (Original mode) (*3) |
| Modem speed | 9,600 / 7,200 / 4,800 / 2,400 bps; Automatic fallback |
| Halftone level | 64-level |
| Scanning density | Horizontal : 8 pels/mm Vertical : 7.7 lines/mm (Fine/Photo), 3.85 lines/mm (Standard) |
| Scanner type | Contact image sensor |
| Printer type | Thermal transfer printing on plain paper |
| Data compression system | Modified Huffman (MH), Original mode |
| Recording paper size | A4: 210 mm x 297 mm (Plain paper) |
| Answering device | Greeting message: Digital recording system (up to 16 sec) Pre-recording greeting message ICM Recording: Digital recording system (Approx. 18 min. in total) (*4) |
| Memory capacity | Max. Approx. 46 pages (Only receiving fax etc.) (*5) Max. Approx. 18 min. (Only Recording message) (*4) |

*1 When copying a 100% black document.

*2 If you can not make a call due to DC resistance, consult your dealer.

*3 Transmission speed is based on an A4-size document of 700 characters sent in standard resolution at 9,600 bps. The actual transmission speed depends upon the contents of the page, resolution, telephone line conditions and capability of the other party's machine.

*4 If there is a silent pause, the total recording time will be longer.

*5 The memory capacity is based on an A4-size document of 700 characters.

