

Facsimile

Quick Reference Guide

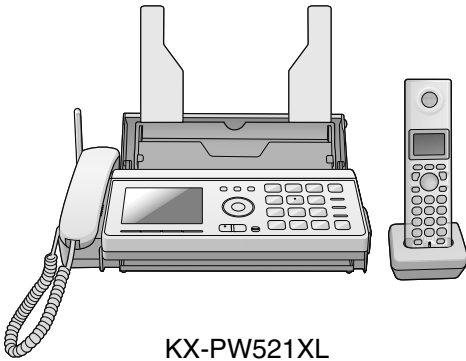

KX-PW521XL

Model No. **KX-PW521XL**
KX-PW521XW

Main unit: KX-PW521
Portable handset: KX-FKN518

Thank you for purchasing a Panasonic product.

Table of Contents

Finding the controls	2
Installations and connections	4
Setting your facsimile telephone number	7
Setting your logo	8
Character input and command key table	9
Voice guide.....	10
Automatic dialing on the main unit.....	11
Automatic dialing on the portable handset (KX-FKN518)	13
Intercom	14
Sending faxes	15
Receiving faxes	16
Operating the built-in answering device	18
Night mode.....	20
Call block	21
SD Memory Card	22
Trademarks	23
Specifications	Back cover

- This guide explains some basic features and operations, but not all of them. For further details, see the Japanese operating instructions.
- This product is designed for use in Japan.
Panasonic cannot provide service for this product if used outside Japan.
- KX-PW521XL includes 1 portable handset and 1 main unit.
KX-PW521XW includes 2 portable handsets and 1 main unit.
- Any details given in this guide are subject to change without notice.

This unit is equipped with the voice guide features. (Japanese only)
For details about voice guide, please see page 10.

Finding the controls

Main unit

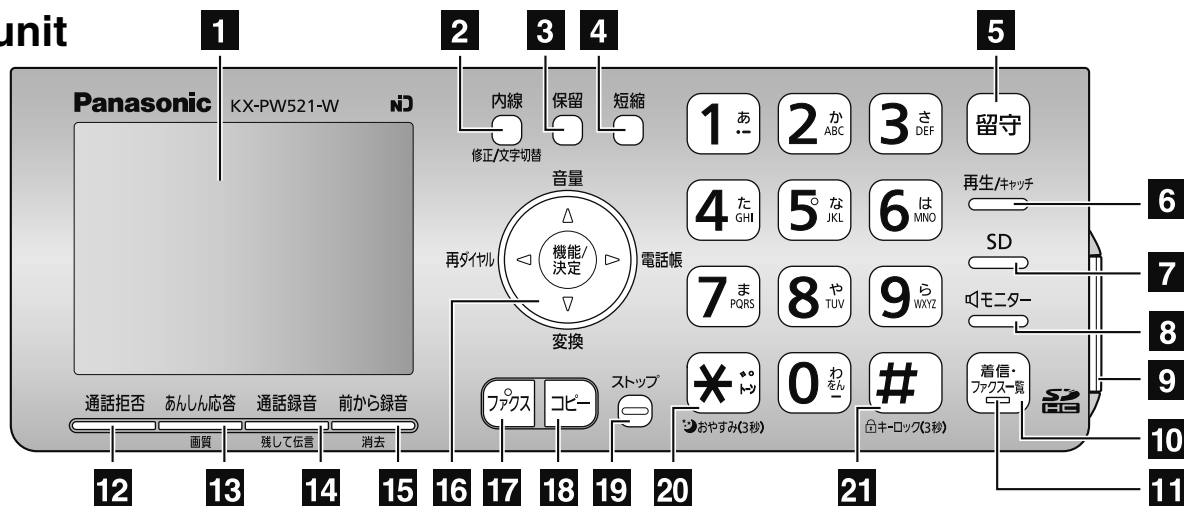

1 Liquid crystal display

2 Intercom/Edit/Character Input Mode button

3 Hold button

4 Speed Dialer button

5 Auto Answer button & indicator

- light on: answering device activated.
- light off: used as a regular telephone.

6 Playback button plays back recorded messages.
Flash button (For call waiting service users.)

7 SD button

8 Monitor button

9 SD Memory Card cover

10 Call/Fax List button starts a search in
— the Number Display (Caller ID) log.
— the fax list stored in memory.

11 Call/Fax List indicator lights when
— a call was missed. (For Number Display service users.)
— a fax was stored in memory.

12 Block button for undesired calls

13 Secure button

While the unit is ringing, press this button. The unit announces a message to the caller. The message is announced in Japanese and means “This unit is currently set to Caller Verifying mode. Could you please speak out your name?”.

- To talk to the caller, lift the handset.
- To hang up, press

Resolution button selects the resolution when faxing or copying.

14 Record button records a telephone conversation. If an SD Memory Card is available (inserted), the telephone conversation will be recorded to the SD Memory Card.

- To record a telephone conversation, press (Record) \Rightarrow (Cancel the precaution voice message).
- To stop recording, press (Stop).

15 Enhanced Record button records the previous 10 minutes of the current telephone conversation. If an SD Memory Card is available (inserted), the telephone conversation will be recorded to the SD Memory Card.

- To record the previous 10 minutes of telephone conversation, press (Enhanced record).
- To stop recording, press (Stop).

Erase button

16 Volume/Change/Redial/Phonebook key



- To adjust the volume (see below).
- To change Hiragana into Kanji.

■ To adjust the **ringer volume** when the unit is on stand by, press \Rightarrow (Select “呼出音量変更”)
 \Rightarrow (Function/Set) \Rightarrow (press repeatedly)
 \Rightarrow (Stop).

■ To adjust the **receiver volume** while talking, press repeatedly.

■ To adjust the **speaker volume** while listening to the recorded messages or using the monitor, press repeatedly.



To redial the phone numbers in the redial list. The last 10 phone numbers dialed are stored in memory.



To use the phonebook.



To register a function or apply a setting.

17 Fax button starts faxing.

18 Copy button starts copying.

19 Stop button

20 Tone button switches to tone dialing.

Night mode button

21 Sharp button









Key lock button can lock the main unit so that no calls or settings can be made. To turn key lock on, press this button for about 3 seconds until a single beep is heard.





- “” is displayed.
- To turn key lock off, press this button for about 3 seconds.

Finding the controls



Portable handset (KX-FKN518)

How to use key

-  ● To use the phonebook.
-  ● To redial the phone numbers in the redial list. The last 10 phone numbers dialed are stored in memory.
-  ● To change Hiragana into Kanji.
- To adjust the volume.
 - To adjust the ringer volume when the portable handset is on stand by, press  (Select “呼出音量”) →  →  (press repeatedly) → .
 - To adjust the receiver volume while talking, press  repeatedly.
 - To adjust the speaker volume while listening to the recorded messages or using the speakerphone, press  repeatedly.

-  ● To make/answer calls.
-  ● To end a call.
- To end or exit from editing or other operations.
-  ● To put a call on hold.
-  ● To start a search in the Number Display log. (For Number Display service users.)
-  ● To page the main unit and/or portable handset(s).

Dial buttons

-  ● Tone button
 - To switch to tone dialing.
-  ● Sharp button
- Key lock button
 - To lock the portable handset so that no calls or settings can be made. To turn key lock on, press this button for about 3 seconds until a single beep is heard.
 - “” is displayed.
 - To turn key lock off, press this button for about 3 seconds until a single beep is heard.

Earpiece

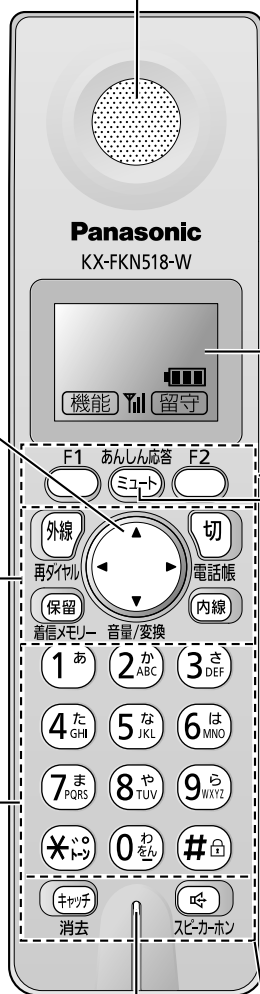



Microphone

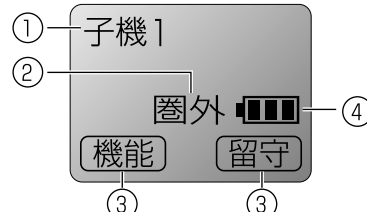

(Do not cover the microphone while talking.)

Liquid crystal display



- ① Portable handset number (and name)
- ② No link to the main unit
- ③ Function menu that is controlled by  or 
- ④ Battery strength

How to use buttons

 and  buttons refer to the function displayed on the bottom of the display. They function differently depending on the mode.

あんしん応答



Secure button

- While the portable handset is ringing, press this button. The portable handset announces a message to the caller. The message is announced in Japanese and means “This unit is currently set to Caller Verifying mode. Could you please speak out your name?”

- To talk to the caller, press .

- To hung up, press .

Mute button

- To mute your voice to the other party by pressing this button. (To release the mute, press this button again.)

 消去

- For call waiting service users.
- To clear letters/numbers.

 スピーカホン

- To use the speakerphone.

Installations and connections

Installing the ink film

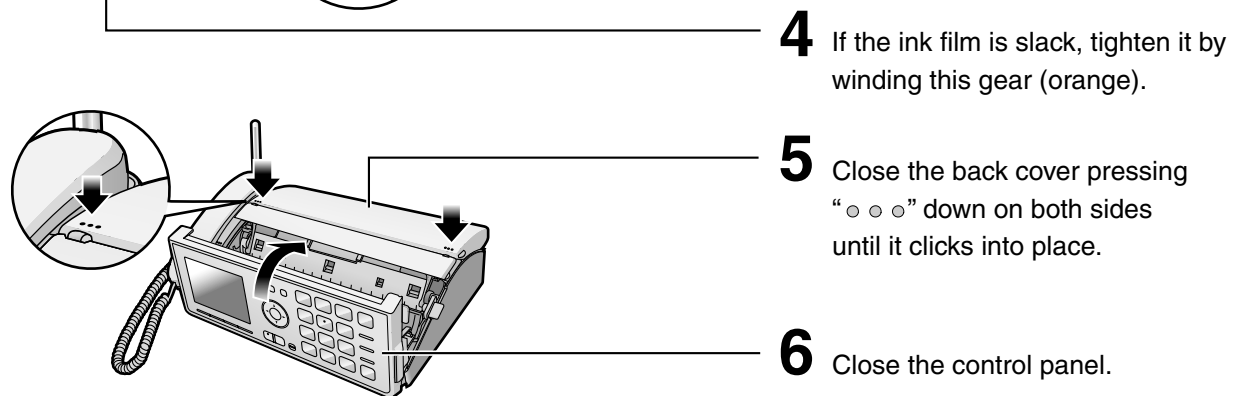
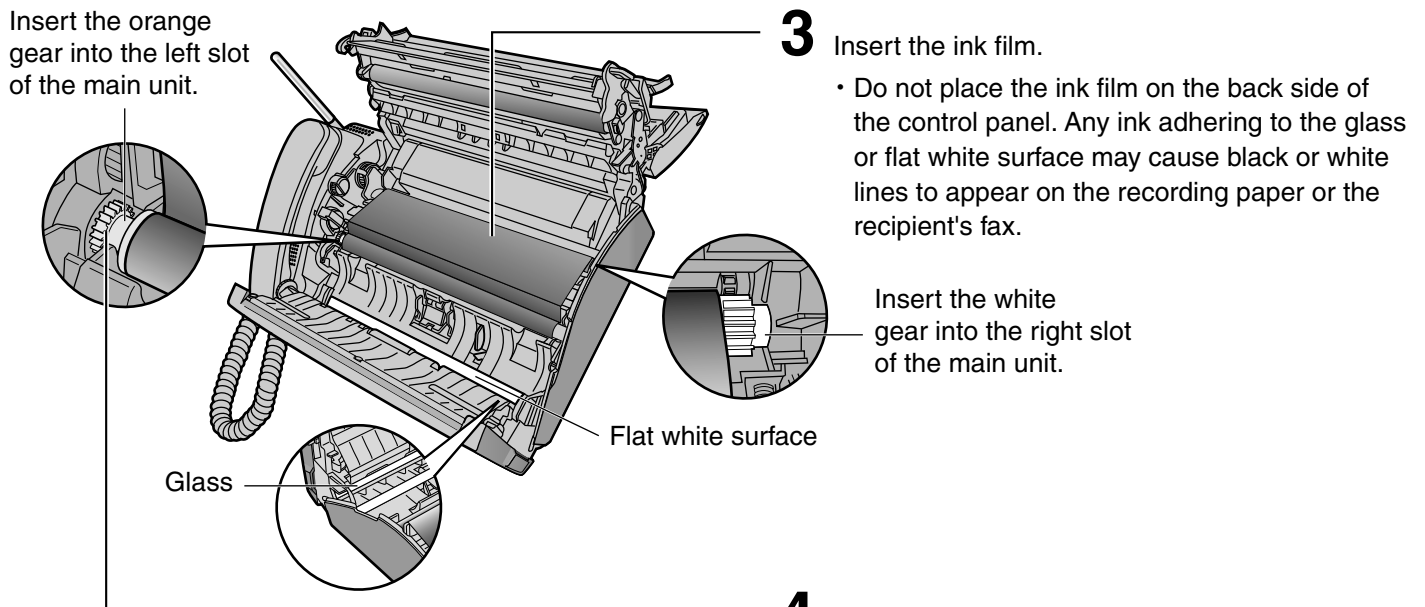
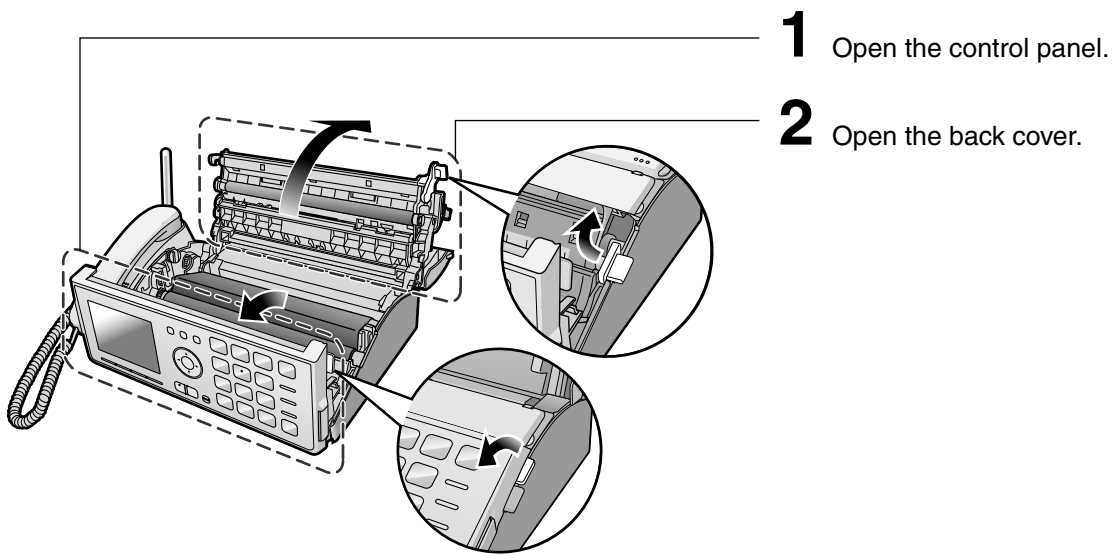

• When the unit runs out of ink film, the following message will be displayed.

フィルムなし U23
交換してください
品番: KX-FAN190

Install a new ink film.

Replacement ink film:	
KX-FAN190 (15 m)	¥714
KX-FAN190W (15 m X 2)	¥1,208
KX-FAN191 (15 m) (*1)	¥893
KX-FAN191W (15 m X 2) (*1)	¥1,523

*1 KX-FAN191/KX-FAN191W leaves a fainter print trail on the film than does the KX-FAN190/190W.

• As of January 2011. • Tax included.

Installations and connections

Installing recording paper (A4 size)

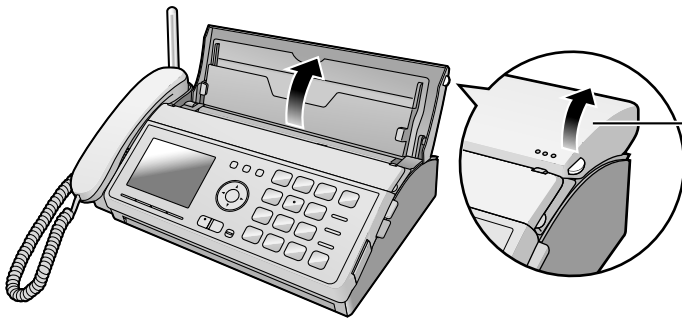

1 Open the recording paper tray.

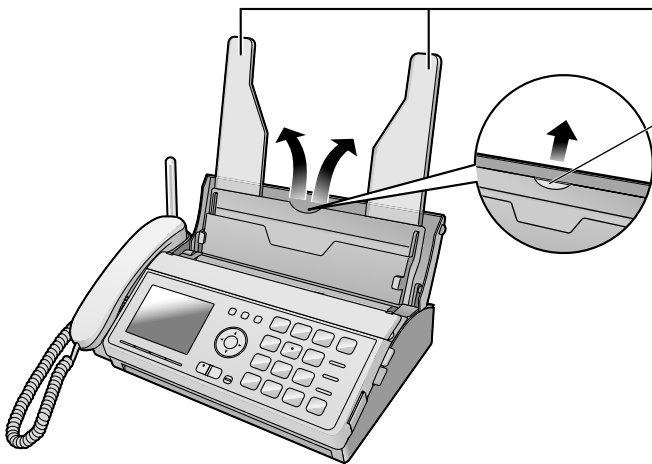

2 Set up the recording paper stands.

Pull out the front stand first.

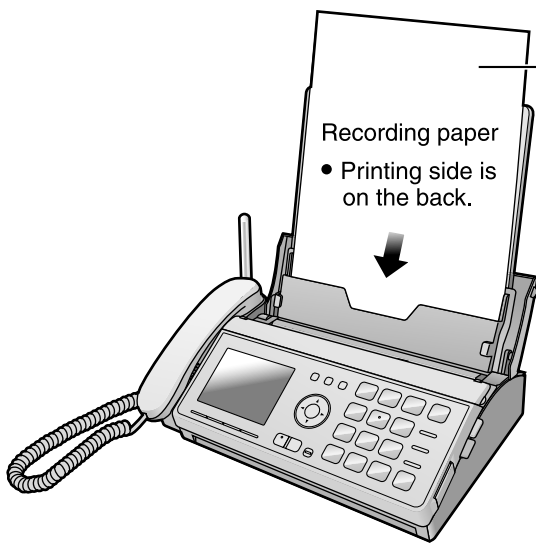

Recording paper
• Printing side is on the back.

3 Insert the recording paper into the recording paper tray. (Up to 15 sheets)

- Fan the stack of recording paper.

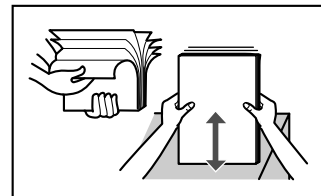

Folding the recording paper tray

① Remove the recording paper and fold the recording paper stands in.



② Close the recording paper tray.

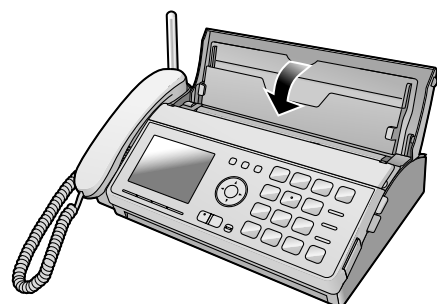

Installations and connections

Connecting the main unit

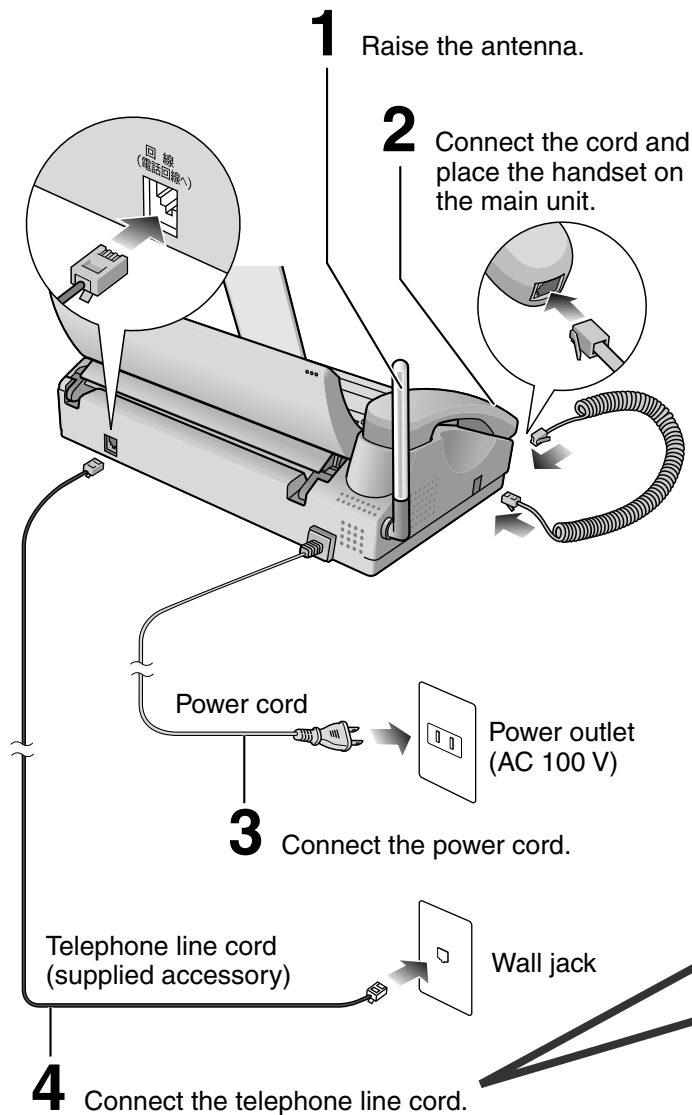

After connecting...

① This unit will automatically select the dialing mode (Pulse/Tone).

② When the following is displayed, press

機能/決定 (Function/Set) to set the date and time.

日付・時刻を設定するには
[機能] 押す

③ Enter the correct year/month/day.

Example: October 1, 2011

Press **2 0 1 1 1 0 0 1**.

日付時刻
2011年10月01日
00:00 [決定] 押す

④ Enter the correct hour/minute in a 24-hour clock entry.

Example: 15:45 (3:45 PM)

Press **1 5 4 5**.

日付時刻
2011年10月01日
15:45 [決定] 押す

⑤ Press 機能/決定 (Function/Set).

⑥ When the following is displayed, press ストップ (Stop).

携帯電話に
かけるとき
電話会社の

↔
Alternating
display

通話料金引きけ-
ズを利用しますか?
はい=* いいえ=#

↓ If you cannot make a call...

Set the dialing mode with the main unit.

1. Press 機能/決定 (Function/Set).

2. Press **# 0 7 9**.

3. Press (Search button) repeatedly until the desired setting is selected.

Example :

回線種別 20

- アツシ : Tone
- 20 : Pulse (20 PPS)
- 10 : Pulse (10 PPS)
- 自動 : Auto (Default)

4. Press 機能/決定 (Function/Set).

5. Press ストップ (Stop).

■ To adjust the date and time

1. Press 機能/決定 (Function/Set), then press **# 0 0 1**.

2. Enter the correct year/month/day/hour/minute.

3. Press 機能/決定 (Function/Set), then press ストップ (Stop).

Installations and connections

Setting up the portable handset (KX-FKN518)

1 Press  on the battery cover and slide the cover.

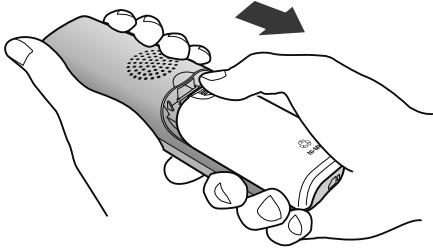

2 Insert the battery into the compartment and close the battery cover.

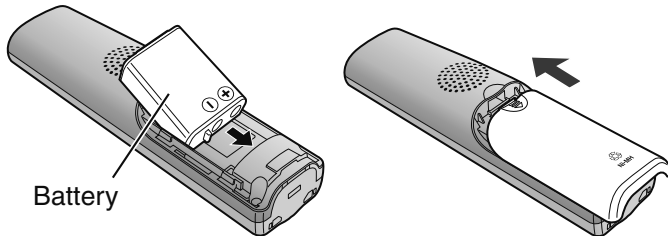

3 Connect the charger to the power outlet, then place the portable handset on the charger for about **10 hours**.

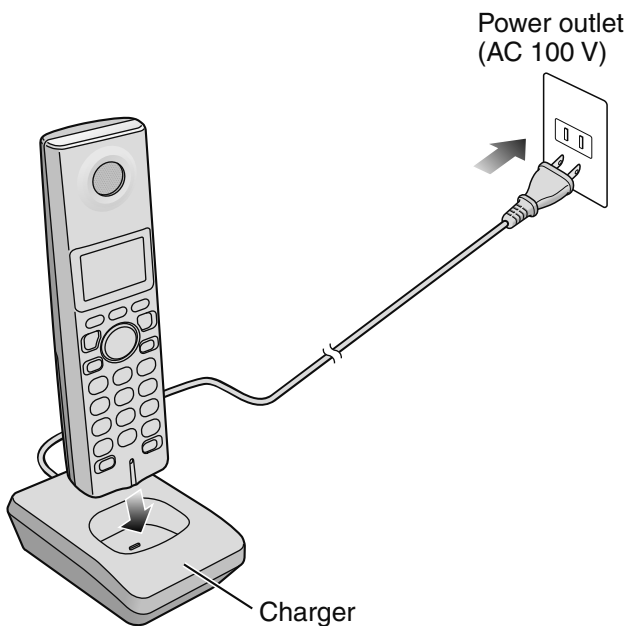

• After your Panasonic battery is fully charged, it will last up to about 5 hours of conversation.

Setting your facsimile telephone number

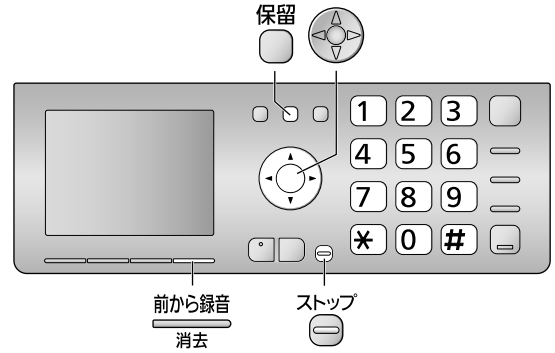

1 Press  (Function/Set).

機能登録モード



2 Press **# 0 0 4**.

あなたの電話番号

3 Enter your facsimile telephone number, up to 20 digits.

Example: +098 7654..

あなたの電話番号
+098 7654..

- The ***** (Tone) button replaces the digit with “+”.
- The  (Hold) button replaces the digit with a space.
- To correct a mistake, press  (Enhanced record/Erase).

4 Press  (Function/Set).

登録しました



あなたの電話番号
☎098 7654..

5 Press  (Stop).

Setting your logo

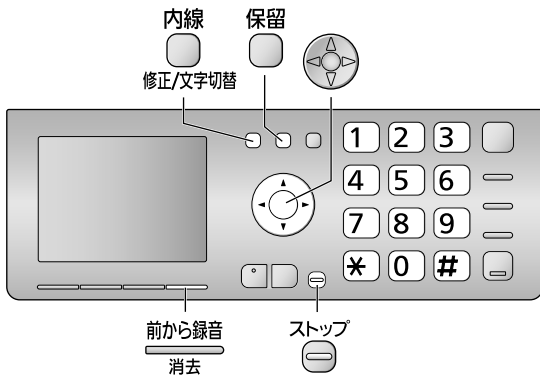

1 Press (Function/Set).

機能登録モード

2 Press .

名前:印刷用 [漢]
Cursor

3 Enter your logo, up to 30 characters, using the dial keypad.

- To enter English characters easily, press (Intercom/Edit/Character input mode) repeatedly and select “英” (English and sign input mode).
- For details, see the table on page 9 for instructions.

Example: Micah

1. Press once.

名前:印刷用 [英]
Cursor

2. Press six times.

名前:印刷用 [英]
Mi

3. Press six times.

名前:印刷用 [英]
Mic

4. Press to move the cursor to the next space and press four times.

名前:印刷用 [英]
Mic

5. Press five times.

名前:印刷用 [英]
Micah

4 Press (Function/Set).

登録しました











名前:印刷用 [漢]
Micah

5 Press (Stop).

Character input and command key table

Pressing the dial keys will select a character as shown below.









Character		Hiragana	Katakana	English	Numbers
Display of the main unit and the portable handset		[漢]	[カ]	[英]	[数]
Dial key					
(Main unit) ①	(Portable handset KX-FKN518) ①	あいうえお あいうえお	アイウエオ アイウエオ	@ . _ - & \$ ¥ % + = ~ ^	1
②	②	かきくけこ	カキクケコ	A B C a b c	2
③	③	さしすせそ	サシスセソ	D E F d e f	3
④	④	たちつてとっ	タチツテトツ	G H I g h i	4
⑤	⑤	なにぬねの	ナニヌネノ	J K L j k l	5
⑥	⑥	はひふへほ	ハヒフヘホ	M N O m n o	6
⑦	⑦	まみむめも	マミムメモ	P Q R S p q r s	7
⑧	⑧	やゆよやゆよ	ヤユヨヤユヨ	T U V t u v	8
⑨	⑨	らりるれろ	ラリルレロ	W X Y Z w x y z	9
⑩	⑩	わをんー! ? ()	ワヲンー! ? ()	! ? / - * # , ; : . ' " () [] { } < > 「 」	0
✳	✳	” ° 、 。		、 。	
Command keys		 (Main unit), 修正/文字切替	 (Portable handset)	Used to change the character input mode.	
		 (Main unit),	 (Portable handset)	Used to move the cursor to the left and right.	
		 (Main unit), 前から録音 消去	 (Portable handset), キヨツ子 消去	Used to delete a character.	
		 (Main unit),	 (Portable handset)	Used to insert a space.	

• The characters on the display are somewhat different from those shown in the character input and command key table.

Voice guide

Operation guide

The unit starts the following voice guidance in Japanese:

Operations	To cancel the operation guide (using the main unit)
Send a fax	 機能/決定 → # 0 2 1 →  (Select “なし”) →  機能/決定 →  ストップ
Copy	
Add entries to the phonebook	 機能/決定 → # 1 6 7 →  (Select “なし”) →  機能/決定 →  ストップ
Store phonebook entries in the speed dialer	
Make a call using the phonebook/redial/ speed dialer/call memory	
Print fax documents from the memory	
Change the ink film	The operation guide for changing the ink film cannot be prevented from starting.

Reading-out dial

The unit announces the number dialed in Japanese, when you make a call with the main unit.

• To cancel the reading-out dial



Reading-out phonebook

The unit reads out stored names* when the phonebook is searched.

• To cancel the reading-out phonebook



Incoming name announcement (for Number Display service subscribers only)

The unit announces the caller's name* when a call is received from a caller whose name and phone number are stored in the phonebook.

• To cancel the incoming name announcement



* Names will only be read out when their “フリガナ” (readings) are stored in katakana in the phonebook. English, numbers and signs in “フリガナ” are not read out.

Automatic dialing on the main unit

Storing names and telephone numbers in the phonebook

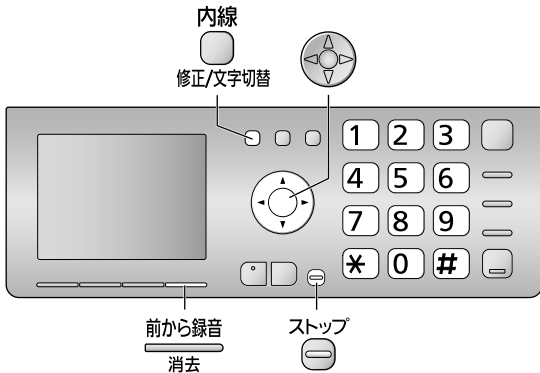

- 1 Press (Phonebook).
 - “XXX” shows the remaining station numbers you can store.
 - You can program up to 150 stations, including 4 pre-programmed stations.
- 2 Press (Function/Set).
- 3 Enter the name, up to 20 characters (see the table on page 9 for instructions).
- 4 Press (Function/Set) 2 times.
- 5 Enter the telephone number, up to 24 digits.
 - To correct a mistake, press (Enhanced record/Erase).
- 6 Press (Function/Set).
- 7 Enter the group number (1 to 9).
- 8 Press (Function/Set).
 - To program other items, repeat steps 3 to 8.
- 9 Press (Stop) to exit the program.

電話帳空き XXX件
登録は [決定] 押す
検索は [▼,▲] 押す

Making a voice call using the phonebook

- 1 Press (Phonebook).
- 2 Press (Search button) repeatedly until the desired name is displayed.
- 3 Lift the handset.

Editing a stored name or number in the phonebook

- 1 Press (Phonebook).
- 2 Press (Search button) repeatedly until the desired name is displayed.
- 3 Press (Intercom/Edit/Character input mode).
- 4 Edit the name (see the table on page 9 for instructions).
 - If you do not need to edit the name, skip to step 5.
- 5 Press (Function/Set).
- 6 Edit the kana.
 - If you do not need to edit the kana, skip to step 7.
- 7 Press (Function/Set).
- 8 Edit the telephone number.
 - If you do not need to edit the telephone number, skip to step 9.
- 9 Press (Function/Set).
- 10 Edit the group number.
 - If you do not need to edit the group number, skip to step 11.
- 11 Press (Function/Set).
- 12 Press (Stop).

Automatic dialing on the main unit

Storing names and telephone numbers in the speed dialer

You can store up to 9 names and telephone numbers which are stored in the phonebook. The dialing buttons (1) to (9) function as memory stations.

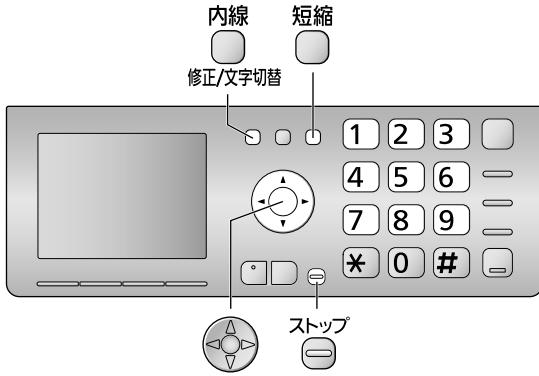

1 Press  (Speed dialer).

2 Press the memory station number (1) to (9).

Example: speed dialer 1

1. 未登録
Memory station number

3 Press  (Intercom/Edit/Character input mode).

4 Press  (Search button) repeatedly until the desired name is displayed.

5 Press  (Function/Set).

- To program other items, repeat steps 2 to 5.

6 Press  (Stop) to exit the program.

Making a voice call using the speed dialer

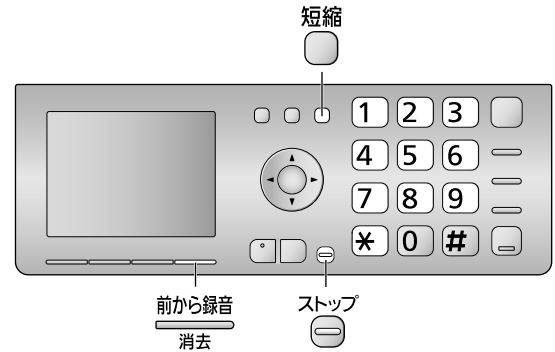

1 Press  (Speed dialer).



2 Press the memory station number (1) to (9).

3 Lift the handset.

Erasing a stored name and number in the speed dialer

1 Press  (Speed dialer).

2 Press the memory station number (1) to (9).

3 Press  (Enhanced record/Erase), then press .

4 Press  (Stop) to exit the program.

Automatic dialing on the portable handset (KX-FKN518)

Storing names and telephone numbers in the phonebook

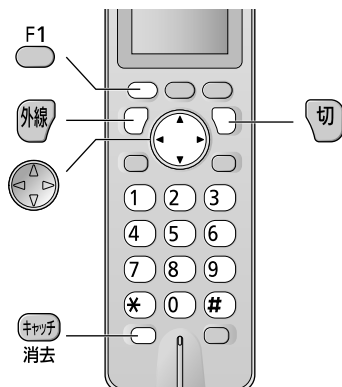

1 Press 電話帳 (Phonebook).

検索は
[▼,▲]を押す

2 Press .

- “XXX” shows the remaining station numbers you can store.
- You can program up to 150 stations, including 4 pre-programmed stations.

名前?
空き XXX件

3 Enter the name, up to 20 characters (see the table on page 9 for instructions).

4 Press 2 times.

5 Enter the telephone number, up to 24 digits.

- To correct a mistake, press (Flash/Erase).

6 Press .

7 Enter the group number (① to ⑨).

8 Press .

- To program other items, repeat steps 3 to 8.

9 Press (Off) to exit the program.

Making a voice call using the phonebook

1 Press 電話帳 (Phonebook).

2 Press (Search button) repeatedly until the desired name is displayed.

3 Press (Talk).

Editing a stored name or number in the phonebook

1 Press 電話帳 (Phonebook).

2 Press (Search button) repeatedly until the desired name is displayed.

3 Press .

4 Edit the name (see the table on page 9 for instructions).

- If you do not need to edit the name, skip to step 5.

5 Press .

6 Edit the kana.

- If you do not need to edit the kana, skip to step 7.

7 Press .

8 Enter the correct telephone number.

- If you do not need to edit the telephone number, skip to step 9.

9 Press .

10 Edit the group number.

- If you do not need to edit the group number, skip to step 11.

11 Press .

12 Press (Off) to exit the program.

Intercom

An intercom is available between the portable handsets or between the main unit and portable handset(s).

Using the main unit:



1 ■ For single portable handset users

- ① Lift the handset.

電話番号?

- ② Press  (Intercom/Edit/Character input mode).

子機1呼出中

■ For multiple portable handset users

- ① Lift the handset.

- ② Press  (Intercom/Edit/Character input mode).

- ③ Call the portable handset(s) in the following ways:
 - To call a specific portable handset, press the portable handset number (1 to 6) which you want to call.
 - To call all the portable handsets, press .

2 Start talking.

Example : 子機1内線通話中

3 Replace the handset to end the intercom call.

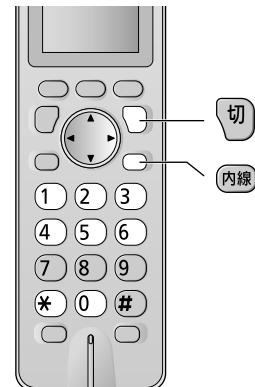

Using the portable handset (KX-FKN518):



1 ■ For single portable handset users

- Press  (Intercom).

■ For multiple portable handset users

- ① Press  (Intercom).
- ② Call the main unit and/or portable handset(s) in the following ways:
 - To call a specific portable handset, press the portable handset number (1 to 6) which you want to call.
 - To call the main unit, press .
 - To call the main unit and all the portable handsets, press .

2 Start talking.



内線通話中

3 Press (Off) to end the intercom call.

Sending faxes

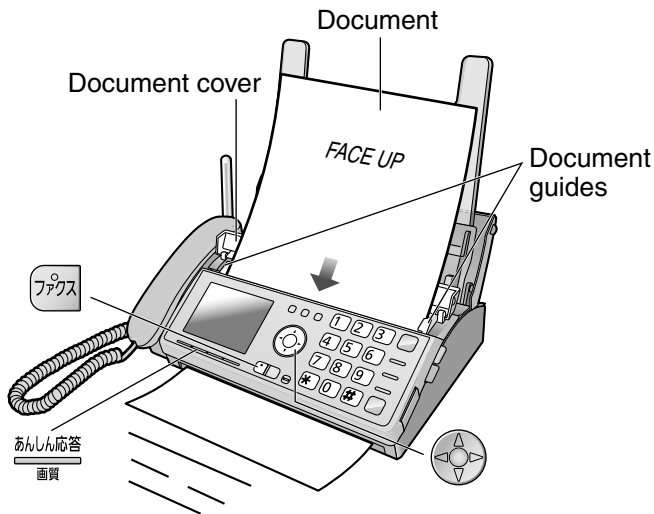
Sending a fax manually



- 1 Open the document cover, and adjust the width of the document guides to the size of the document.
- 2 Insert the document (up to 5 pages) FACE UP until a single beep is heard.
- 3 If necessary, press  (Search button) repeatedly to select the desired resolution while “画質=” is displayed (see below).
- 4 Press  (Fax).
- 5 Dial the fax number.
- 6 Press  (Fax).
 - The unit will start fax transmission.

To select the resolution

Select the desired resolution according to the type of document, by pressing  repeatedly while “画質=” is displayed.



To display “画質=”, press  (Secure/Resolution).

- | | |
|---------|---|
| 画質=ふつう字 | (Standard) for printed or typewritten originals with normal-sized characters. |
| 画質=小さい字 | (Fine) for originals with minute printing. |
| 画質=写真 | (Photo) for originals containing photographs. |

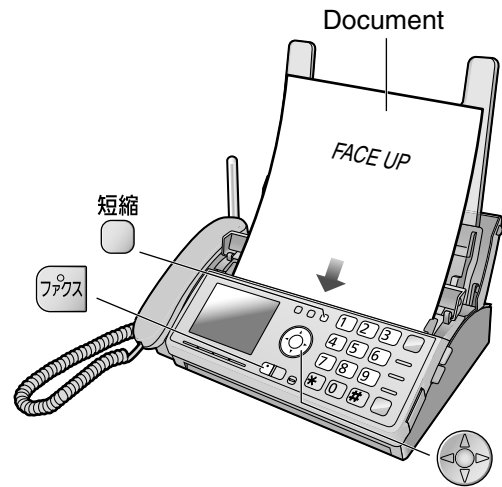



Sending a fax using automatic dialing



Using the phonebook

- 1 Insert the document (up to 5 pages) FACE UP until a single beep is heard.
- 2 Press  (Phonebook).
- 3 Press  (Search button) repeatedly until the desired name is displayed.
- 4 Press  (Fax).
 - The unit will start fax transmission.

Using the speed dialer

- 1 Insert the document (up to 5 pages) FACE UP until a single beep is heard.
- 2 Press  (Speed dialer).
- 3 Press the memory station number ( to ).
- 4 Press  (Fax).
 - The unit will start fax transmission.

Receiving faxes



You can select whether to receive faxes on recording paper or in memory.

Receive on recording paper : The received fax will be printed on recording paper. If an SD Memory Card is inserted, it will also be stored in the SD Memory Card. When the unit runs out of the recording paper or the ink film, the received fax will be stored in the main unit memory or the SD Memory Card.

Receive in memory : The received fax will be stored in the main unit memory or the SD Memory Card. To check the contents, print them. (You cannot check the contents on the display.)

■ To receive on recording paper

Insert the recording paper into the recording paper tray beforehand.

■ To receive in memory

Remove the recording paper from the recording paper tray.

When new faxes are received in memory,  (Call/Fax list indicator) will light on.

- It will also light on when a call is missed. (For Number Display service users.)
- If an SD Memory Card is inserted, new faxes will be received in the SD Memory Card.

When you want to print the received faxes, insert the recording paper into the recording paper tray, and print them.

Receiving a fax manually (AUTO ANSWER off)



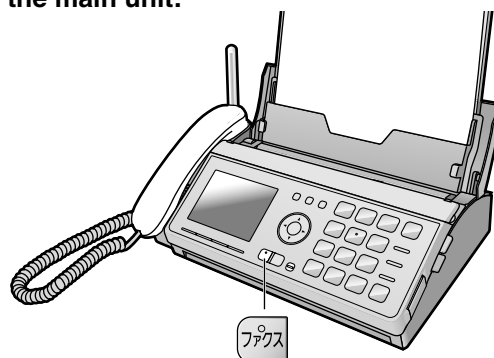

Using the main unit:

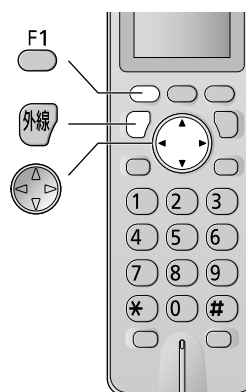

- 1 When you hear a ring, lift the handset to answer the call.
- 2 When:
 - document reception is required,
 - a fax calling tone (slow beep) is heard, or
 - no sound is heard,
 press  (Fax), then replace the handset.
 - The unit will start fax reception.

Using the portable handset (KX-FKN518):



- 1 When you hear a ring, lift the portable handset from the charger, then press  (Talk) to answer the call.
- 2 When:
 - document reception is required,
 - a fax calling tone (slow beep) is heard, or
 - no sound is heard,
 press .
- 3 Press  (Search button) repeatedly until the “ファクス受信” is displayed, then press .
- 4 Press .
 - The main unit will start fax reception.

Receiving faxes

Receiving a fax automatically (AUTO ANSWER on)



- 1 If the **留守** (Auto answer) light is off, turn it on by pressing **留守**.
- 2 When receiving a call, the unit will receive a fax document or record a voice message automatically depending on the caller's request.

Printing all the new faxes received in the memory

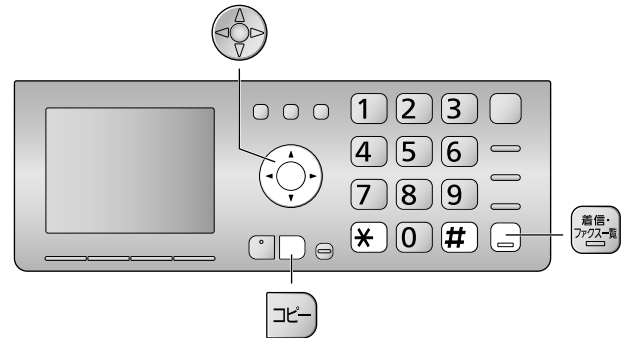

When new faxes are received in memory, the following will be displayed.

ファクス届いています
[着信・ファクス一覧]
押す

You can print all the new faxes.

- Any new faxes stored in the SD Memory Card will also be printed.

1 ■ When not using Number Display Service

Press **着信・ファクス一覧** (Call/Fax list).

■ When using Number Display Service

Press **着信・ファクス一覧** (Call/Fax list), then

press **検索** (Search button).

The total number of stored faxes.

ファクス 10件
新規(マーク) 3件
検索は[決定]押す

The number of new faxes.

2 Press **コピー** (Copy).

3 After printing, the following will be displayed.

Do you delete the ——— 印刷した内容を
printed contents? 消去しますか?

- If you want to delete the faxes, press *****.
- If you want to hold the faxes, press **#**.

Receiving faxes

Printing a specific fax stored in memory



1 ■ When not using Number Display Service

Press (Call/Fax list).

■ When using Number Display Service

Press (Call/Fax list), then press

(Search button).

ファクス	10件
新規(*マーク)	3件

2 Press (Function/Set).

3 Press (Search button) to select the desired fax to print, then press (Copy).

4 After printing, the following is displayed.

Do you delete the _____ 印刷した内容を
消去しますか？

- If you want to delete the fax, press .
- If you want to hold the fax, press .

Deleting a specific fax stored in memory

1 ■ When not using Number Display Service

Press (Call/Fax list).

■ When using Number Display Service

Press (Call/Fax list), then press

(Search button).

ファクス	10件
新規(*マーク)	3件

2 Press (Function/Set).

3 Press (Search button) to select the desired fax to delete.

4 Press (Enhanced record/Eraser).

Do you delete the fax ? _____ 消去しますか？

or

This fax has not been _____ 印刷
printed. されていません

Do you delete the fax ? _____ 消去しますか？

5 If you want to delete the fax, press .

- If you want to hold the fax, press .

6 If you want to delete other faxes, repeat steps 3 to 5.

7 Press (Stop).

Operating the built-in answering device

Recording your own greeting message

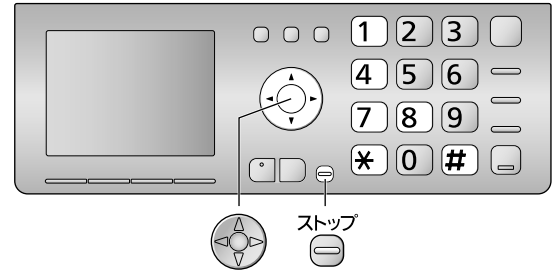

You can record your own greeting message. When receiving a call, it will be played to callers instead of the pre-recorded Japanese greeting message.

1 Press (Function/Set).

2 Press .

自作応答録音

3 Press (Function/Set).

4 Lift the handset.

5 Press (Function/Set) and speak your greeting message after a beep, up to 16 seconds, to the handset.

6 Press (Stop) and replace the handset.

- Your greeting message will be played back automatically.

Erasing your own greeting message

1 Press (Function/Set).

2 Press .

自作応答消去

3 Press (Function/Set).

4 Press .

- The pre-recorded Japanese greeting message will be played when you receive a call.

Operating the built-in answering device

Activating the answering device

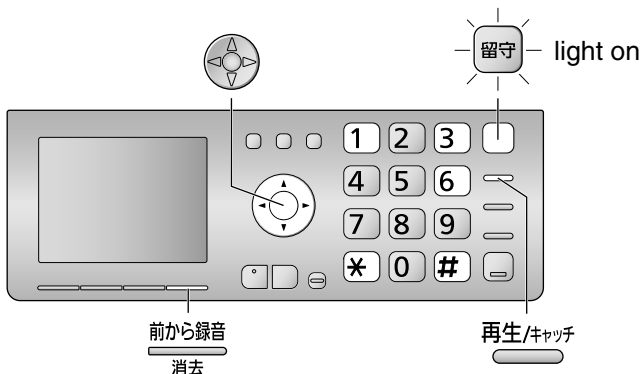

If an SD Memory Card is available (inserted), voice messages will be recorded to the SD Memory Card. (See page 22.)

1 Turn the **留守** (Auto answer) light on by pressing **留守**.

2 When receiving a call, a greeting message will be played and the unit will record a voice message.
• To record your own greeting message, see page 18.

Listening to recorded messages

When new messages are recorded, the **留守** (Auto answer) light will flash.

Press **留守** to listen to recorded messages.

再生 1 / 2件
means recorded — 10月 2日 11:45
date and time : Oct. 2, 11:45

When playing a message in the SD Memory Card, **SD再生** will be displayed.

After the messages are played back, the following will be displayed.

- To erase the messages, press *****.
- To save the messages, press **#**.

再生した用件を
消去しますか？

Listening to all of the recorded messages

Press **再生/キヤッチ** (Playback/Flash) when new messages are not recorded.

- When new messages are recorded, only the new messages will be played back.

After the messages are played back, the following will be displayed.

すべて
消去しますか？

- To erase the messages, press *****.
- To save the messages, press **#**.

Erasing a specific message

Press **前から録音 消去** (Enhanced record/Erase) while listening to the message you want to erase, then press *****.

Erasing all of the recorded messages

1 Press **機能/決定** (Function/Set).

2 Press **# 1 6 3**.

3 Press **機能/決定** (Function/Set).

用件をすべて
消去しますか？

- When not using an SD Memory Card, press *****.
- When using an SD Memory Card, delete messages as follows:
 - To erase the main unit memory messages and the SD Memory Card messages, press **機能/決定** (Search button) repeatedly until “**本体メモリー + SDカード**” (Main unit memory + SD card) is displayed, then press **機能/決定** (Function/Set), *****.
 - To erase the main unit memory messages, press **機能/決定** (Search button) repeatedly until “**本体メモリー**” (Main unit memory) is displayed, then press **機能/決定** (Function/Set), *****.
 - To erase the SD Memory Card messages, press **機能/決定** (Search button) repeatedly until “**SDカード**” (SD card) is displayed, then press **機能/決定** (Function/Set), *****.

Operating the built-in answering device

Operating the answering device from a remote location

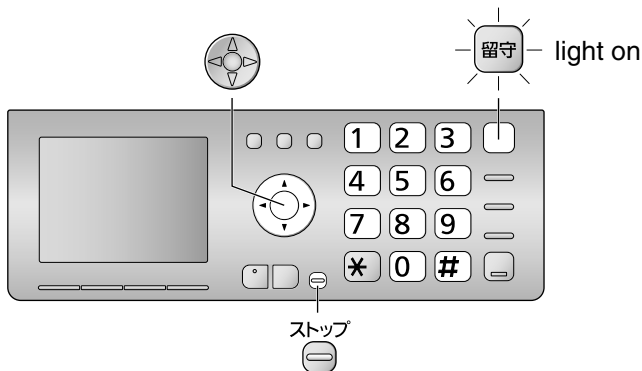

Preparation: Programming the remote operation ID

1. Press (Function/Set).
2. Press **# 0 0 6**.
3. Enter any 4-digit number (remote operation ID) except * or #.

Example : 留守電暗証番号
1234

4. Press (Function/Set).
5. Press (Stop).

Operation: Listening to a recorded message from a remote location

Turn the (Auto answer) light on before you go out. Remote operations are available only from a touch tone telephone.

1. Call your unit.
2. Enter the remote operation ID during the greeting message.
3. Press **2** or wait 4 seconds.
 - Only the new recorded messages will be played back.
 - To listen to all the recorded messages, press **4** after the new messages have been played back.

Night mode

Turn on the night mode



Press (Night mode) for about 3 seconds.

- “” is displayed and lights on.
- When a call is received during night mode, the unit will handle the call silently, either by storing the received fax into memory or by recording the caller's message.
- Night mode allows you to select a block of time during which the unit will not ring for outside calls or make sounds when you change the settings. This feature is useful when you do not want to be disturbed, for example, while sleeping.

Listening to recorded messages

When new messages are recorded, the following will be displayed.

新しい用件が
録音されました

Press (Playback/Flash) to listen to recorded messages.

After the messages are played back, the following will be displayed.

再生した用件を
消去しますか?

- To erase the messages, press .
- To save the messages, press .

Printing received fax documents

When new faxes are received, (Call/Fax list indicator) will light on.

To print the faxes, see "Printing a specific fax stored in memory" on page 18.

To print the faxes in the SD Memory Card, see page 23.

Turn off the night mode

Press (Night mode) for about 3 seconds.

Call block

Blocking the incoming calls

Using the main unit:

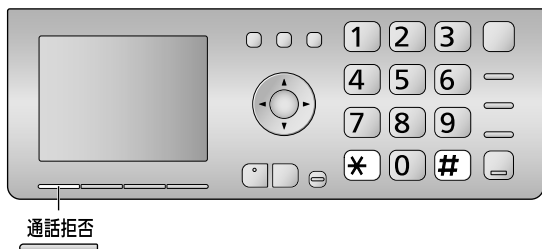

To block a call using a message

While the unit is ringing, press 通話拒否 (Block).

OR

While you are on an incoming call, press 通話拒否 (Block),

then press *.

- The unit announces a message to the caller 2 times, then hangs up automatically. The message is announced in Japanese and means “We’re sorry, but your call cannot be connected.”

To block a call using chimes

1 While you are on an incoming call, press 通話拒否 (Block).

2 Press #.

- Chimes are heard by the caller.

3 Explain to the caller that a visitor came and hang up.

Using the portable handset (KX-FKN518):

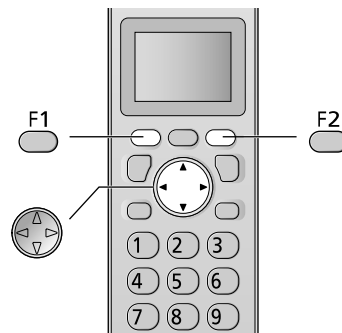

To block a call using a message

While the unit is ringing, press F1 2 times.

OR

While you are on an incoming call,

1 Press F1.

2 Press Search (Search button) repeatedly until “通話拒否” is displayed.

3 Press F1 2 times.

- The unit announces a message to the caller 2 times, then hangs up automatically. The message is announced in Japanese and means “We’re sorry, but your call cannot be connected.”

To block a call using chimes

1 While you are on an incoming call, press F1.

2 Press Search (Search button) repeatedly until “通話拒否” is displayed, then press F1.

3 Press Search (Search button) repeatedly until “チャイム” is displayed, then press F1.

4 Explain to the caller that a visitor came and hang up.

For Number Display service subscribers

- If you subscribe to Number Display service, the message heard by the caller will change according to the caller’s situation.

Example : If the caller requested not to send caller’s information, the message heard by the caller will change to mean “Your phone number is blocked by service provider. Please call again with adding ‘186’ to the beginning of the phone number.”

- When the following is displayed after blocking an incoming call, you can set the unit to block future calls from the same telephone number.

Using the main unit:

■ To block the call, press *.

迷惑設定
しますか？

■ To cancel blocking, press #.

- When the following is displayed, press # to cancel.

拒否設定
しますか？

Using the portable handset:

■ To block the call, press F1.

迷惑設定
しますか？

■ To cancel blocking, press F2.

- When the following is displayed, press F2 to cancel.

拒否設定
しますか？

SD Memory Card

Compatible SD Memory Card

- SD Memory Card (2 GB or less)
- SDHC Memory Card (32 GB or less)

SD indicator

- The SD indicator appears on the display when an SD Memory Card is inserted.
- The SD indicator flashes while reading or writing to the SD Memory Card.



SD indicator

- Never remove the card or unplug the power cord while the SD indicator is flashing.

Inserting the SD Memory Card

Open the SD Memory Card cover, and insert the SD Memory Card in the direction of the arrow.

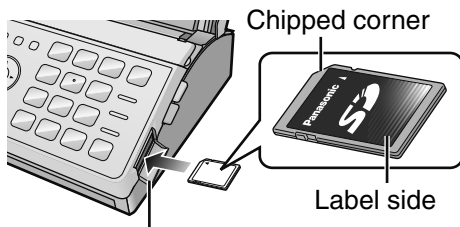

SD Memory Card cover

Removing the SD Memory Card

While the SD indicator is displayed (not flashing), open the cover, push the SD Memory Card in the direction of the arrow, then pull it out.

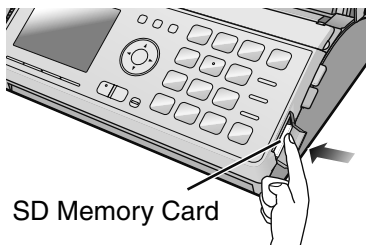

Saving all voice messages from the main unit memory to the SD Memory Card

- 1 Press **SD** (SD).
- 2 Press (Search button) repeatedly until the following is displayed.

すべての用件を
SDへ保存する
- 3 Press (Function/Set).
- 4 Press *****.
- 5 ■ To erase the messages in the main unit, press *****.
■ To save the messages in the main unit, press **#**.

Listening to /Deleting voice messages from the SD Memory Card

- 1 Press **SD** (SD).
- 2 Press (Search button) repeatedly until the following is displayed.

SDの用件一覧
- 3 Press (Function/Set) 2 times.

SD 1 / 3件
*10月 3日 18:45 — October 3rd, 18:45
松下 太郎 (Date and time of recording)
- 4 Press (Search button) to select the desired message.
- 5 ■ To listen to the voice message, press **再生/キャッチ** (Playback/Flash).
■ To delete the voice message, press **前から録音 消去** (Enhanced record/Erase), *****.









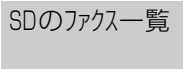

Saving all faxes from the main unit memory to the SD Memory Card

- 1 Press **SD** (SD).
- 2 Press (Search button) repeatedly until the following is displayed.

すべてのファクスを
SDへ保存する
- 3 Press (Function/Set).
- 4 Press *****.
- 5 ■ If you want to delete the faxes, press *****.
■ If you want to hold the faxes, press **#**.

SD Memory Card

Printing/Deleting faxes from the SD Memory Card





- 1 Press  (SD).
- 2 Press  (Search button) repeatedly until the following is displayed.

- 3 Press  (機能/決定) (Function/Set) 2 times.
- 4 Press  (Search button) to select the desired fax to print/delete.
- 5 ■ To print the fax, press  (Copy).
After printing:
 - If you want to delete the fax, press .
 - If you want to hold the fax, press .■ To delete the fax, press  (前から録音 消去) (Enhanced record/Erase), .

Displaying documents/Listening voice messages on a PC

- OS environment
 - Microsoft® Windows® 98 operating system
 - Microsoft® Windows® Millennium Edition operating system
 - Microsoft® Windows® 2000 operating system
 - Microsoft® Windows® XP operating system
 - Microsoft® Windows Vista® operating system
 - Microsoft® Windows® 7 operating system
- Image file : (TIFF format)
Folder : \PRIVATE\MEIGROUP\PCC\FAX\DOC
- Audio file : (WAVE format : It can be played using Windows Media® Player or QuickTime.)
Folder : \PRIVATE\MEIGROUP\PCC\FAX\REC

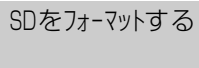
Formatting SD Memory Card

To use an SD Memory Card formatted on a PC or other device, format it as follows.
Formatting the SD Memory Card deletes all stored data; this data cannot be recovered.

- 1 Press  (SD).
- 2 Press  (Search button) repeatedly until the following is displayed.

- 3 Press  (機能/決定) (Function/Set).
- 4 Press .

Trademarks

- Microsoft, Windows, Windows Vista and Windows Media are either registered trademarks or trademarks of Microsoft Corporation in the United States and/or other countries.
- QuickTime is a trademark of Apple Computer, Inc., registered in the U.S. and other countries.
- All other trademarks identified herein are the property of their respective owners.

Specifications

KX-PW521XL KX-PW521XW	Main unit	Portable handset (KX-FKN518)	Battery charger
Power supply	AC 100 V (50 Hz/60 Hz)	Ni-MH battery (Part no. KX-FAN51) DC 3.6 V, 650 mAh	AC 100 V (50 Hz/60 Hz)
Power consumption	Transmission: Approx. 10 W Reception: Approx. 15 W Copy: Approx. 16 W Stand by: Approx. 0.6 W (When the F-net service is not in use.) Maximum(*1): Approx. 130 W		<ul style="list-style-type: none"> • Charging: Approx. 1.2 W • Stand by: Approx. 0.5 W (When the portable handset is off the charger.)
Dimensions (H x W x D)	Approx. 86 X 296 X 191 mm (without handset, projections) Approx. 265 X 296 X 231 mm (recording paper tray opened, without handset, projections)	Approx. 171 X 44.5 X 33.5 mm	Approx. 34 X 72.5 X 100.5 mm
Mass (Weight)	Approx. 2.4 kg (10 m ink film installed)	Approx. 157 g (battery installed)	Approx. 160 g
Operating environment	5 °C – 35 °C, 45 % – 85 % RH (Relative Humidity)		

KX-PW521XL KX-PW521XW	Main unit
Applicable line	Public Switch Telephone Network (Pulse/Tone), F-Net, NCC Lines
DC resistance	280 Ω
Compatibility	G3 compatible
Document size	A4–A5 (Max. 210 mm in width, Max. 530 mm in length)
Effective scanning size	208 mm (A4)
Effective printing size	202 mm (A4 size plain paper)
Transmission time	Approx. 15 s/page (Original mode) (*2)
Modem speed	9,600 / 7,200 / 4,800 / 2,400 bps; Automatic fallback
Halftone level	64-level
Scanning density	Horizontal: 8 pels/mm Vertical : 7.7 lines/mm (Fine/Photo), 3.85 lines/mm (Standard)
Scanner type	Contact image sensor
Printer type	Thermal transfer printing on plain paper
Data compression system	Modified Huffman (MH), Original mode
Recording paper size	A4: 210 mm x 297 mm (Plain paper)
Answering device	Greeting message: Digital recording system (up to 16 sec) Pre-recording greeting message ICM Recording: Digital recording system (Approx. 12 min. in total)
SD Memory Card capacity	Image data(such as received faxes) : Max.1000 data/Max.approx. 50000 sheets (*3) using 32 GB SDHC Memory Card Audio data(such as recorded messages): Max.1000 data/Max.approx.1101 hours using 32 GB SDHC Memory Card
SD Memory Card format	FAT16/FAT12 (SD Memory Card), FAT32 (SDHC Memory Card)
Main unit memory capacity	Max. Approx. 50 pages (Only receiving fax etc.) (*3) Max. Approx. 12 min. (Only recording message)

*1 When copying a 100 % black document.

*2 Transmission speed is based on an A4-size document of 700 characters sent in standard resolution at 9,600 bps. The actual transmission speed depends upon the contents of the page, resolution, telephone line conditions and capability of the other party's machine.

*3 The memory capacity is based on an A4-size document of 700 characters sent in standard resolution (8 x 3.85 lines/mm).