

Facsimile

# Quick Reference Guide

Model No. **KX-PW777E3**

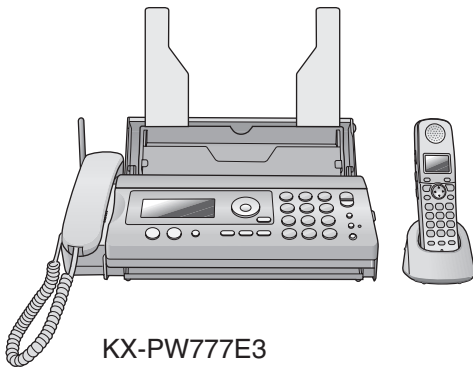

KX-PW777E3

Main unit: KX-PW777  
Portable handset: KX-FKN512

Thank you for purchasing a Panasonic facsimile.

## Table of Contents

Finding the controls .....	2
Installations and connections .....	4
Setting the date and time.....	7
Setting your facsimile telephone number .....	7
Setting your logo .....	8
Character input and command key table .....	9
Voice guide.....	10
Automatic dialing on the main unit .....	11
Automatic dialing on the portable handset (KX-FKN512) .....	13
Intercom .....	14
Sending faxes .....	15
Receiving faxes .....	16
Operating the built-in answering device .....	17
Night mode.....	18
Call block .....	19
Adjusting the volume of a TV (KX-FKN512) .....	20
Specifications .....	21

- This guide explains some basic features and operations, but not all of them. For further details, see the Japanese operating instructions.
- This product is designed for use in Japan.  
Panasonic cannot provide service for this product if used outside Japan.
- Any details given in this guide are subject to change without notice.

**This unit is equipped with the voice guide features. (Japanese only)**  
For details about voice guide, please see page 10.

# Finding the controls

## Main unit

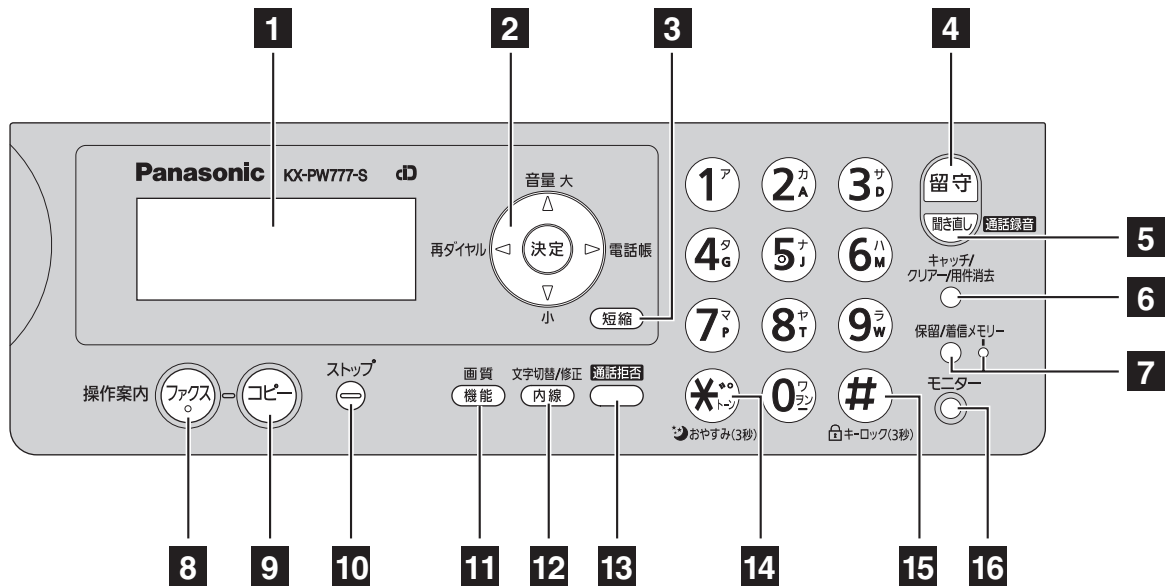

### 1 Liquid crystal display

### 2 Volume/Redial/Phonebook/Set key



To adjust the volume.



To redial the phone numbers in the redial list. The last 10 phone numbers dialed are stored in memory.



To use the phonebook.



To store a parameter.

### 3 Speed Dialer button

### 4 Auto Answer button & indicator

—light on: answering device activated.  
—light off: used as a regular telephone.

### 5 Replay button plays back recorded messages.

**Record** button records a telephone conversation.

### 6 Flash button

(For call waiting service users.)

**Clear/Erase** button

### 7 Hold button

**Call Memory** button starts a search in the Number Display (Caller ID) log.

**Call Memory** indicator lights when a call was missed.

(For Number Display service users.)

### 8 Fax button starts faxing.

### 9 Copy button starts copying.

### 10 Stop button

### 11 Resolution button selects the resolution when faxing or copying.

**Function** button initiates programming.

### 12 Character Input Mode/Edit button

**Intercom** button

### 13 Block button for the undesired call

### 14 Tone button switches to tone dialing.

**Night mode** button

### 15 Sharp button

**Key lock** button can lock the main unit so that no calls or settings can be made. To turn key lock on, press this button for about 3 seconds until a single beep is heard.

- “ ” is displayed.

- To turn key lock off, press this button for about 3 seconds.

### 16 Monitor button

# Finding the controls

## Portable handset (KX-FKN512)

### Liquid crystal display

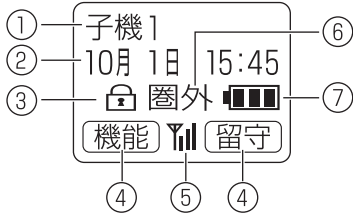

- ① ..... Portable handset number (and name)
- ② ..... Date and time (set by main unit)
- ③ ..... Key lock is on
- ④ ..... Function menu that is controlled by F1 or F2
- ⑤ ..... Link strength to the main unit
- ⑥ ..... No link to the main unit
- ⑦ ..... Battery strength

### How to use F1 F2 buttons

F1 and F2 buttons refer to the function displayed on the bottom of the display. They function differently depending on the mode.

### How to use 音量/変換 key

- 電話帳 ● To use the phonebook.
- 再ダイヤル ● To redial the phone numbers in the redial list. The last 10 phone numbers dialed are stored in memory.
- 音量/変換 ● To adjust the volume.
- To change Hiragana into Kanji.

### Dial buttons

- トーン ● To switch to tone dialing.
- Sharp button ● To lock the portable handset so that no calls or settings can be made. To turn key lock on, press this button for about 3 seconds until a single beep is heard.
  - “” is displayed.
  - To turn key lock off, press this button for about 3 seconds.

- キヤッチ ● For call waiting service users.

- ボイスチェンジ ● To change your voice.
- To mute your voice to the other party by pressing this button for about 2 seconds. (To release the mute, press this button again.)

- スピーカーホン ● To use the speakerphone.

Earpiece

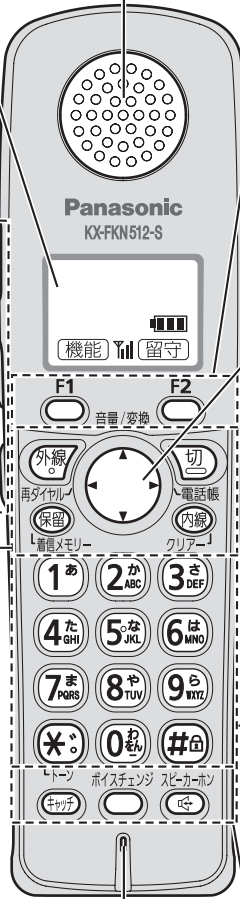

Microphone

(Do not cover the microphone while talking.)

- テレビ消音 ● To mute the TV volume.

- テレビ音量 ● To adjust the TV volume.

- 外線 ● To make/answer calls.

- 切 ● To end a call.
- To end or exit from editing or other operations.

- 内線 ● To page the main unit and/or portable handset(s).
- クリアー ● To clear letters/numbers.

- 保留 ● To put a call on hold.
- 着信メモリー ● To start a search in the Number Display log. (For Number Display service users.)

# Installations and connections

## Installing the ink film

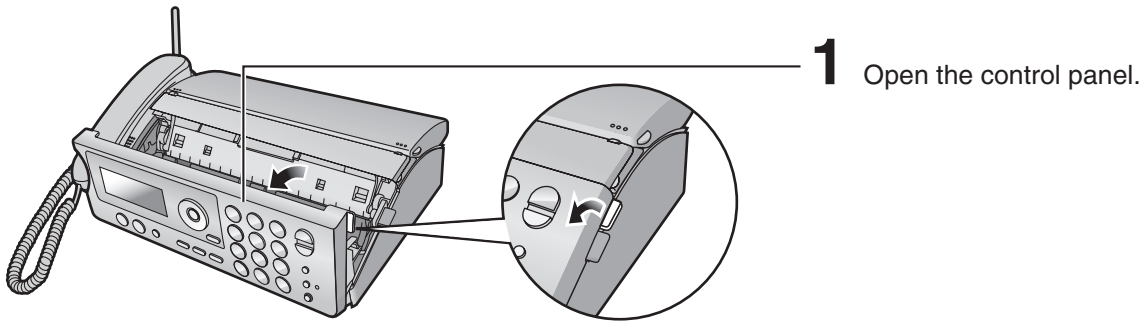

**1** Open the control panel.

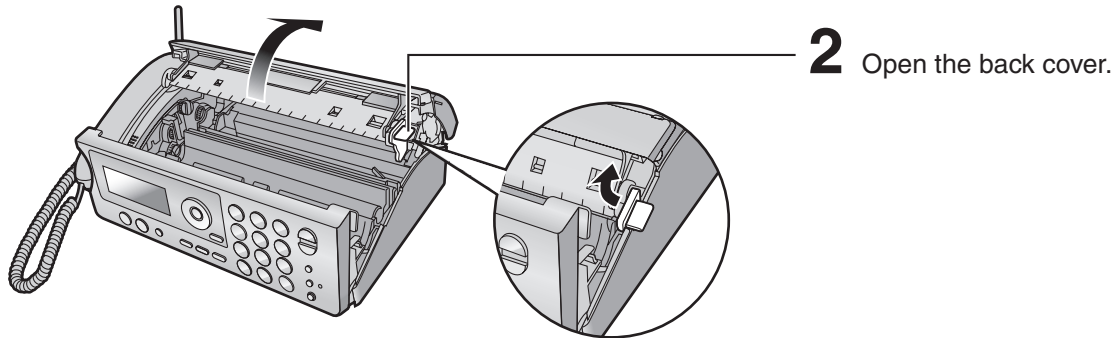

**2** Open the back cover.

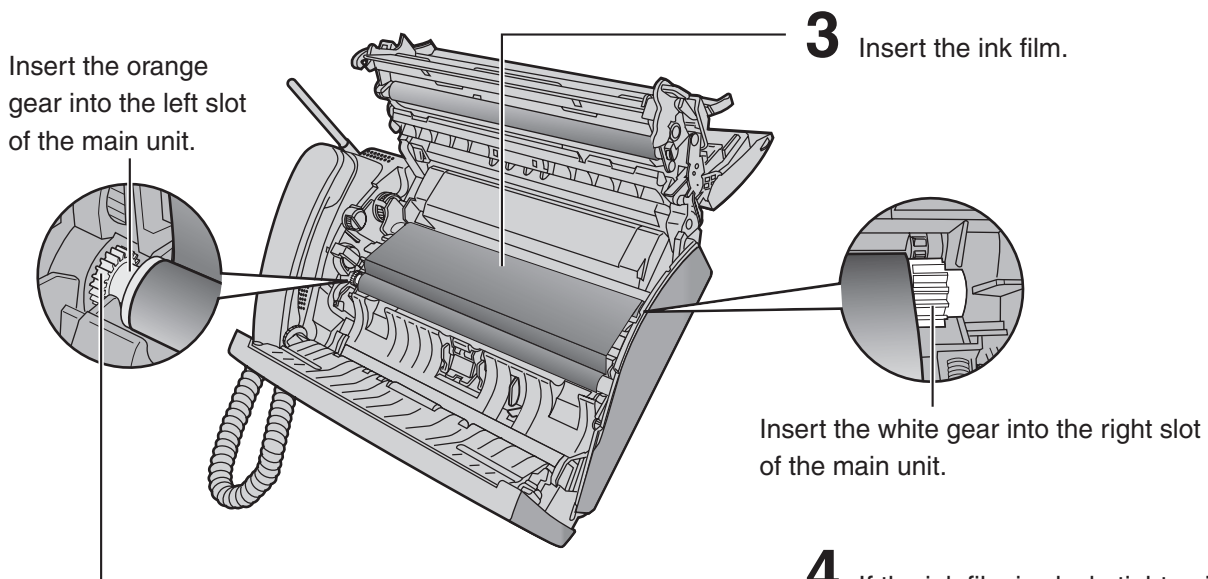

Insert the orange gear into the left slot of the main unit.

**3** Insert the ink film.

Insert the white gear into the right slot of the main unit.

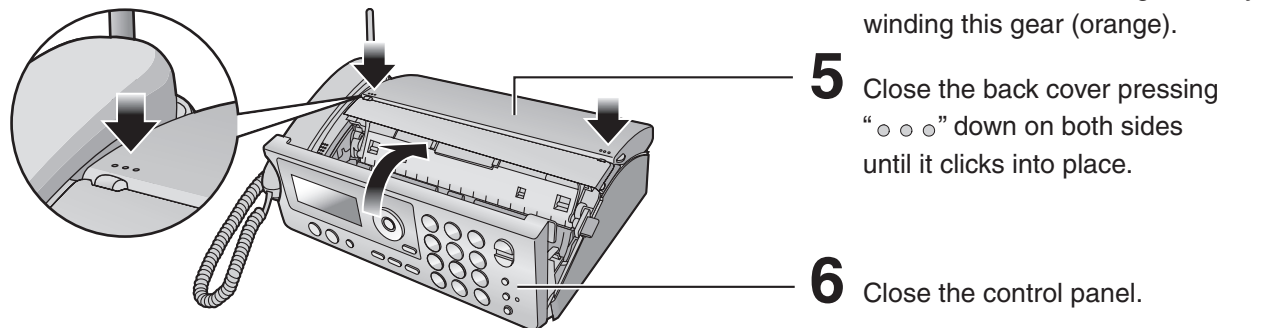

**4** If the ink film is slack, tighten it by winding this gear (orange).

**5** Close the back cover pressing “○○○” down on both sides until it clicks into place.

**6** Close the control panel.

• When the unit runs out of ink film, the following message will be displayed.

フィルムガ ナクナリマシタ コウカンシテクタ サイ U23	↔	フィルムガ ナクナリマシタ ヒンパソ : KX-FAN190
----------------------------------	---	-----------------------------------

Install a new ink film.

Replacement ink film:	
<b>KX-FAN190</b> (15 m)	¥714
<b>KX-FAN190W</b> (15 m X 2)	¥1,208

· As of February 2007.

· Tax included.

# Installations and connections

## Installing recording paper (A4 size)

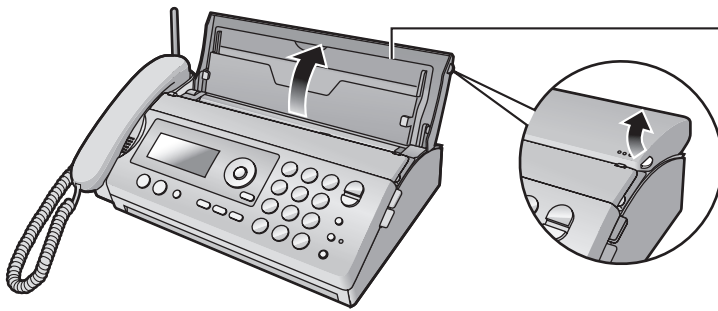

**1** Open the recording paper tray.

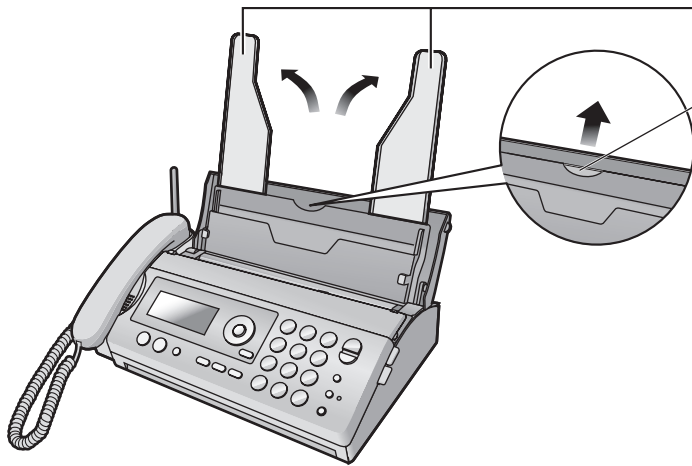

**2** Set up the recording paper stands.

Pull out the front stand first.

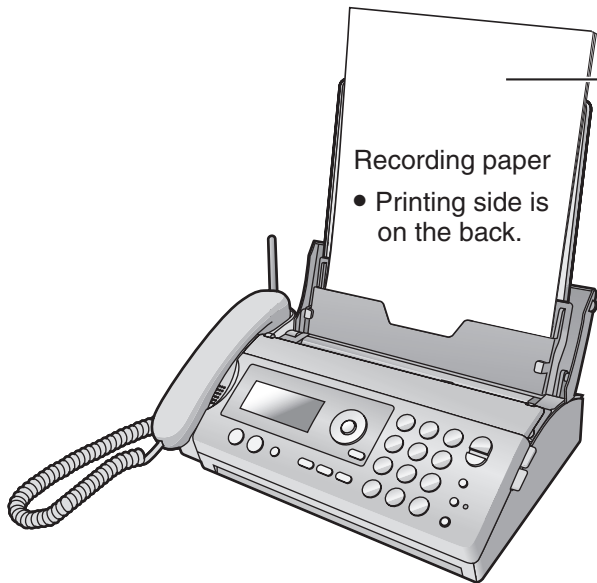

**3** Insert the recording paper into the recording paper tray. (Up to 15 sheets)

- Fan the stack of recording paper.

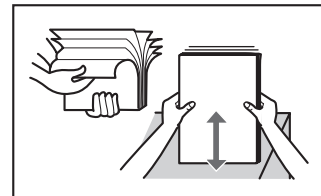

## Folding the recording paper tray

① Remove the recording paper and fold the recording paper stands in.



② Close the recording paper tray.

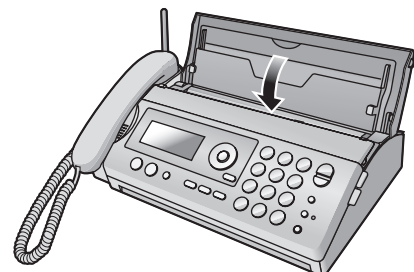

# Installations and connections

## Connecting the main unit

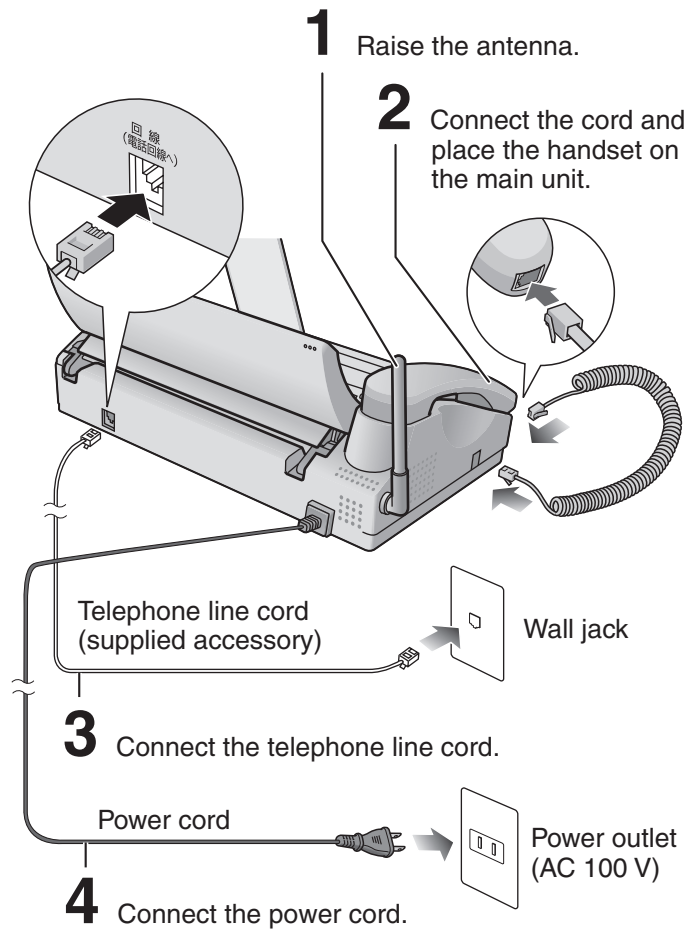

### After the Power On...

This unit will automatically select the dialing mode (Tone/Pulse).



### If you can not make a call...

Set the dialing mode with the main unit.

1. Press (Resolution/Function).
2. Press .
3. Press (Search button) repeatedly until the desired setting is displayed.

#### Example :

カイセシユハツ=20 [◀, ▶, ケツテイ]オス	● フッシュ: Tone
	20 : Pulse (20 PPS)
	10 : Pulse (10 PPS)

4. Press (Set).

5. Press (Stop).

## Setting up the portable handset (KX-FKN512)

**1**

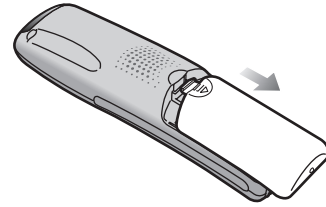

**2**

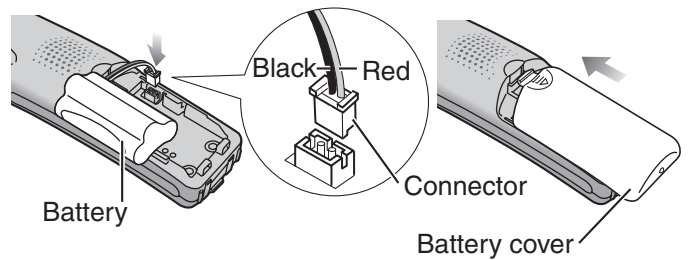

**3**

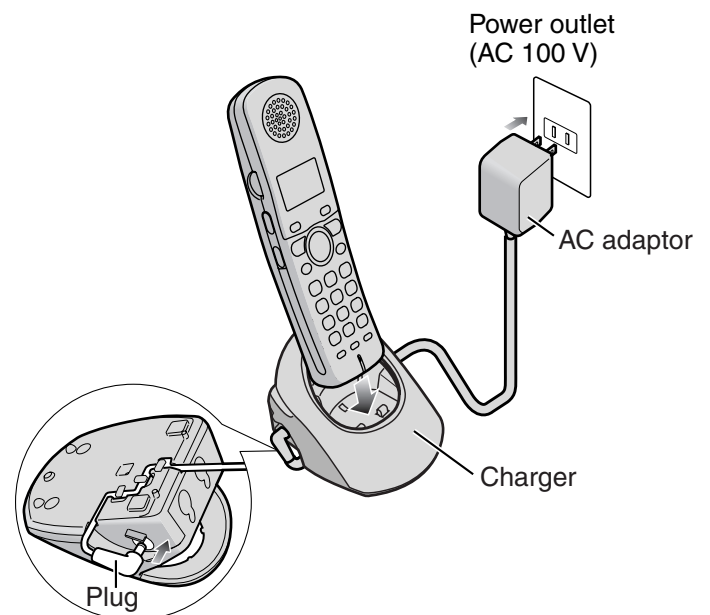

- 4** Charge the battery in the charger **for 10 hours.**

- After your Panasonic battery is fully charged, it will last up to about 7 hours of conversation.



# Setting the date and time

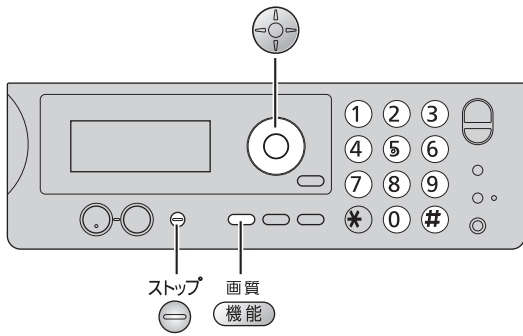

**1** Press **画質機能** (Resolution/Function).

キノウ トウロク モード  
[▼,▲]オス

**2** Press **# 0 0 1**.

**Example :** 2007年09月30日  
15:00  
Cursor

**3** Enter the correct year/month/day.

**Example: October 1, 2007**

Press **2 0 0 7 1 0 0 1**.

2007年10月01日  
15:00

**4** Enter the correct hour/minute in a 24-hour clock entry.

**Example: 15:45 (3:45 PM)**

Press **1 5 4 5**.

2007年10月01日  
15:45

**5** Press **決定** (Set).

トウロク シマシタ



2007年10月01日  
15:45

**6** Press **ストップ** (Stop).

**Example :** 10月 1日 15:45  
ヨウケン ロクオン 0ケン

# Setting your facsimile telephone number

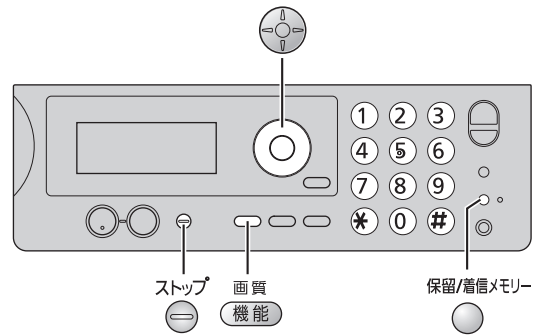

**1** Press **画質機能** (Resolution/Function).

キノウ トウロク モード  
[▼,▲]オス

**2** Press **# 0 0 4**.

アナタノテレホンバツゴウ?  
TEL=.....  
Cursor

**3** Enter your facsimile telephone number, up to 20 digits.

**Example: +098 7654..**

アナタノテレホンバツゴウ?  
TEL=+098 7654..

- The **\* (Tone)** button replaces the digit with "+".
- The **保留/着信メモリー** (Hold/Call memory) button replaces the digit with a space.

**4** Press **決定** (Set).

トウロク シマシタ



アナタノテレホンバツゴウ?  
TEL=+098 7654..

**5** Press **ストップ** (Stop).

**Example :** 10月 1日 15:45  
ヨウケン ロクオン 0ケン

# Setting your logo

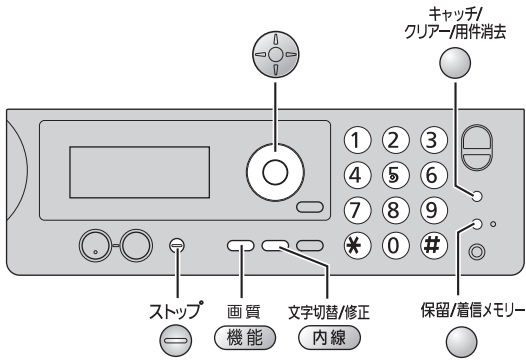

**1** Press **画質機能** (Resolution/Function).

キノウ トウロク モード  
[▼,▲]オス

**2** Press **# 0 0 2**.

アナタノナマI? [カナ]  
Cursor

**3** Enter your logo, up to 30 characters, using the dial keypad.

- To enter English characters easily, press **文字切替/修正内線** (Character input mode/Edit/Intercom) repeatedly and select "AB" (English and sign input mode).
- For details, see the table on page 9 for instructions.

## Example: Micah

**1.** Press **6** once.

アナタノナマI? [AB]  
M  
Cursor

**2.** Press **4** six times.

アナタノナマI? [AB]  
Mi

**3.** Press **2** six times.

アナタノナマI? [AB]  
Mic

**4.** Press **決定** to move the cursor to the next space and press **2** four times.

アナタノナマI? [AB]  
Mica

**5.** Press **4** five times.

アナタノナマI? [AB]  
Micah

**4** Press **決定** (Set).

トウロク シマシタ  
↓  
アナタノナマI? [カナ]  
Micah

**5** Press **ストップ** (Stop).





**Example :** 10月 1日 15:45  
ヨウケン ロクオン 0ケン







# Character input and command key table

Pressing the dial keys will select a character as shown below.

## Main unit

Character Display Dial key	Katakana [カナ]	English [AB]	Numbers [12]
①	アイウエオアイウエオ	@ . _ - & \$ ¥ % + = ~ ^	1
②	カキクケコ	A B C a b c	2
③	サシスセソ	D E F d e f	3
④	タチツテトツ	G H I g h i	4
⑤	ナニヌネノ	J K L j k l	5
⑥	ハヒフヘホ	M N O m n o	6
⑦	マミムメモ	P Q R S p q r s	7
⑧	ヤユヨヤユヨ	T U V t u v	8
⑨	ラリルレロ	W X Y Z w x y z	9
⑩	ワヲンー! ? ( )	! ? / - * # , ; :   · ' " ( ) [ ] { } < > 「 」	0
✳	” ° 、 。	、 。	
Command keys	 文字切替/修正 内線	Used to change the character input mode.	
		Used to move the cursor to the left and right.	
	 キャッチ/ クリア/用件消去	Used to delete a character.	
	 保留/着信メモリー	Used to insert a space.	

## Portable handset

Character Display Dial key	Hiragana [かな]	Katakana [カナ]	English [英]	Numbers [数]
①	あいうえおあいうえお	アイウエオアイウエオ	@ . _ - & \$ ¥ % + = ~ ^	1
②	かきくけこ	カキクケコ	A B C a b c	2
③	さしすせそ	サシスセソ	D E F d e f	3
④	たちつてとつ	タチツテトツ	G H I g h i	4
⑤	なにぬねの	ナニヌネノ	J K L j k l	5
⑥	はひふへほ	ハヒフヘホ	M N O m n o	6
⑦	まみむめも	マミムメモ	P Q R S p q r s	7
⑧	やゆよやゆよ	ヤユヨヤユヨ	T U V t u v	8
⑨	らりるれろ	ラリルレロ	W X Y Z w x y z	9
⑩	わをんー! ? ( )	ワヲンー! ? ( )	! ? / - * # , ; :   · ' " ( ) [ ] { } < > 「 」	0
✳	” ° 、 。		、 。	
Command keys	 F2	Used to change the character input mode.		
		Used to move the cursor to the left and right.		
	 内線 クリア	Used to delete a character.		
	 保留	Used to insert a space.		

• The characters on the display are somewhat different from those shown in the character input and command key table.

## Operation guide

The unit starts the following voice guidance in Japanese:

Operations	To cancel the operation guide
Send a fax	画質機能 → # 0 2 1 → (Select “ナシ”) → 決定 → ストップ
Copy	
Add entries to the phonebook	
Store phonebook entries in the speed dialer	画質機能 → # 1 6 7 → (Select “ナシ”) → 決定 → ストップ
Make a call using the phonebook/redial/ speed dialer/call memory	
Change a ink film	画質機能 → # 1 7 3 → (Select “ナシ”) → 決定 → ストップ
Print fax documents from the main unit memory	画質機能 → # 1 7 7 → (Select “ナシ”) → 決定 → ストップ

## Error announcements

The unit alerts you with announcements in Japanese when the following occur:

- The back cover is opened while sending a fax or printing
- The recording paper runs out or jams
- The ink film runs out
- The document paper jams or does not eject properly

### • To cancel the error announcements



## Reading-out dial

The unit announces the number dialed in Japanese, when you make a call with the main unit.

### • To cancel the reading-out dial



# Automatic dialing on the main unit

## Storing names and telephone numbers in the phonebook

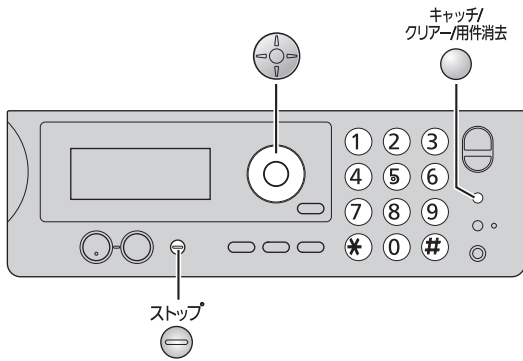

**1** Press 電話帳 (Phonebook).

トウロク ハ [ケツテイ]オス  
ケンサク ハ [▼,▲]オス

**2** Press 決定 (Set).

- “XXX” shows the remaining station numbers you can store.
- You can program up to 150 stations, including 4 pre-programmed stations.

テ ンワチヨウ アキXXXケン

**3** Enter the name, up to 12 characters (see the table on page 9 for instructions).

**4** Press 決定 (Set).

**5** Enter the telephone number, up to 24 digits.

- To correct a mistake, press キャッチ/クリアー/用件消去 (Flash/Clear/Erase).

**6** Press 決定 (Set).

**7** Enter the group number (① to ⑨).

**8** Press 決定 (Set).

- To program other items, repeat steps 3 to 8.

**9** Press ストップ (Stop) to exit the program.

## Making a voice call using the phonebook

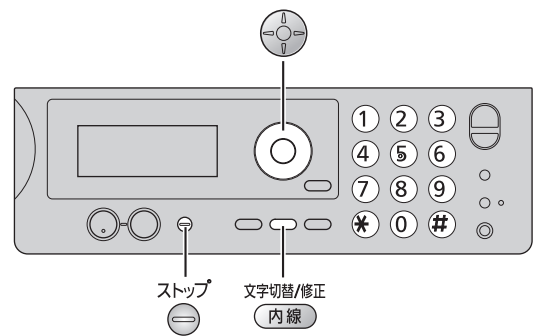

**1** Press 電話帳 (Phonebook).

**2** Press (Search button) repeatedly until the desired name is displayed.

**3** Lift the handset.

## Editing a stored name or number in the phonebook

**1** Press 電話帳 (Phonebook).

**2** Press (Search button) repeatedly until the desired name is displayed.

**3** Press 文字切替/修正 内線 (Character input mode/Edit/Intercom).

**4** Edit the name (see the table on page 9 for instructions).

- If you do not need to edit the name, skip to step 5.

**5** Press 決定 (Set).

**6** Edit the telephone number.

- If you do not need to edit the telephone number, skip to step 7.

**7** Press 決定 (Set).

**8** Edit the group number.

- If you do not need to edit the group number, skip to step 9.

**9** Press 決定 (Set).

**10** Press ストップ (Stop).

# Automatic dialing on the main unit

## Storing names and telephone numbers in the speed dialer

You can store up to 9 names and telephone numbers which are stored in the phonebook. The dialing buttons (① to ⑨) function as memory stations.

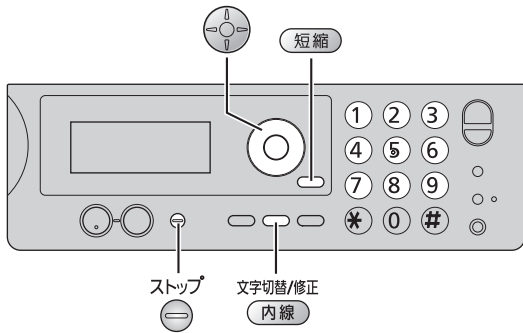

**1** Press **短縮** (Speed dialer).

**2** Press the memory station number (① to ⑨).

**Example: speed dialer 1**

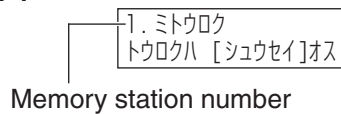

**3** Press **文字切替/修正 内線** (Character input mode/Edit/Intercom).

**4** Press **決定** (Search button) repeatedly until the desired name is displayed.

**5** Press **決定** (Set).

- To program other items, repeat steps 2 to 5.

**6** Press **ストップ** (Stop) to exit the program.

## Making a voice call using the speed dialer

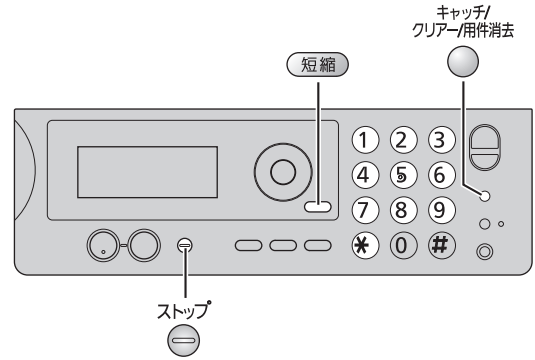

**1** Press **短縮** (Speed dialer).

**2** Press the memory station number (① to ⑨).

**3** Lift the handset.

## Erasing a stored name and number in the speed dialer

**1** Press **短縮** (Speed dialer).

**2** Press the memory station number (① to ⑨).

**3** Press **キャッチ/クリアー/用件消去** (Flash/Clear/Eraser) and **\***.

**4** Press **ストップ** (Stop) to exit the program.

# Automatic dialing on the portable handset (KX-FKN512)

## Storing names and telephone numbers in the phonebook

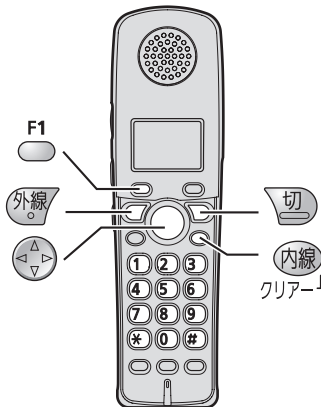

**1** Press 電話帳 (Phonebook).

**2** Press F1.

- “XXX” shows the remaining station numbers you can store.
- You can program up to 150 stations, including 4 pre-programmed stations.

**3** Enter the name, up to 20 characters (see the table on page 9 for instructions).

**4** Press F1 2 times.

**5** Enter the telephone number, up to 24 digits.

- To correct a mistake, press 内線 (Clear).

**6** Press F1.

**7** Enter the group number (**1** to **9**).

**8** Press F1.

- To program other items, repeat steps 3 to 8.

**9** Press 切 (Off) to exit the program.

## Making a voice call using the phonebook

**1** Press 電話帳 (Phonebook).

**2** Press (Search button) repeatedly until the desired name is displayed.

**3** Press 外線 (Talk).

## Editing a stored name or number in the phonebook

**1** Press 電話帳 (Phonebook).

**2** Press (Search button) repeatedly until the desired name is displayed.

**3** Press F1.

**4** Edit the name (see the table on page 9 for instructions).

- If you do not need to edit the name, skip to step 5.

**5** Press F1.

**6** Edit the kana.

- If you do not need to edit the kana, skip to step 7.

**7** Press F1.

**8** Enter the correct telephone number.

- If you do not need to edit the telephone number, skip to step 9.

**9** Press F1.

**10** Edit the group number.

- If you do not need to edit the group number, skip to step 11.

**11** Press F1.

**12** Press 切 (Off) to exit the program.

検索は  
[▼,▲]を押す

名前?  
空き XXX 件

# Intercom

An intercom is available between the portable handsets or between the main unit and portable handset(s).

## Using the main unit:

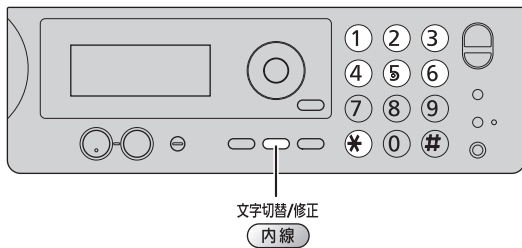

### 1 ■ For single portable handset users

- ① Lift the handset.

デソバソウ?

- ② Press <sup>文字切替/修正</sup> 内線 (Character input mode/Edit/Intercom).

コキヨヒダシチュウ

### ■ For multiple portable handset users

- ① Lift the handset.
- ② Press <sup>文字切替/修正</sup> 内線 (Character input mode/Edit/Intercom).
- ③ Call the portable handset(s) in the following ways:
  - To call a specific portable handset, press the portable handset number (① to ⑥) which you want to call.
  - To call all the portable handsets, press \*.

### 2 Start talking.

Example : コキナイセンツウチュウ

### 3 Replace the handset to end the intercom call.

## Using the portable handset (KX-FKN512):

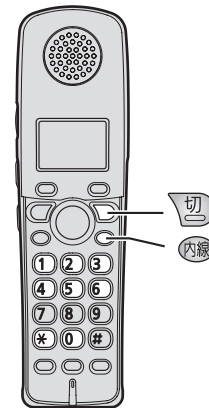

### 1 ■ For single portable handset users

- Press 内線 (Intercom).

### ■ For multiple portable handset users

- ① Press 内線 (Intercom).
- ② Call the main unit and/or portable handset(s) in the following ways:
  - To call a specific portable handset, press the portable handset number (① to ⑥) which you want to call.
  - To call the main unit, press 0.
  - To call the main unit and all the portable handsets, press \*.

### 2 Start talking.

内線通話中

### 3 Press 切 (Off) to end the intercom call.

# Sending faxes

## Sending a fax manually

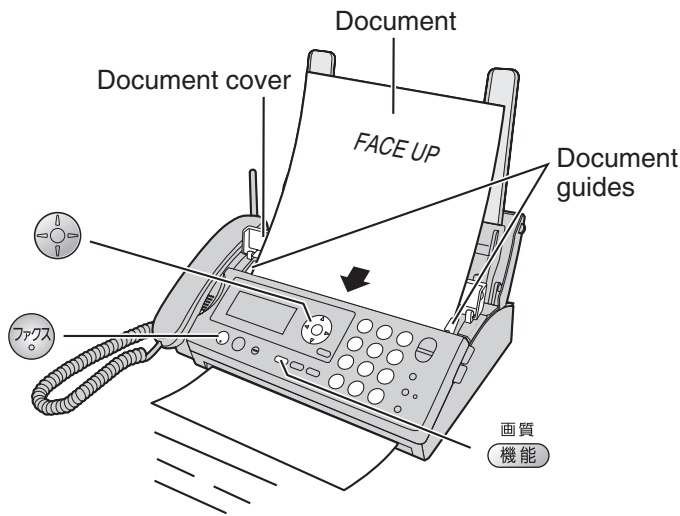

- 1 Open the document cover, and adjust the width of the document guides to the size of the document.
- 2 Insert the document (up to 5 pages) FACE UP until a single beep is heard.
- 3 If necessary, press (Resolution/Function), then press repeatedly to select the desired setting (see below).
- 4 Press (Fax).
- 5 Dial the fax number.
- 6 Press (Fax).
  - The unit will start fax transmission.

### To select the resolution

Select the desired resolution according to the type of document, by pressing (Resolution/Function), then press repeatedly.

[▼, ▲] (Standard) for printed or typewritten originals with normal-sized characters.

[▼, ▲] (Fine) for originals with minute printing.

[▼, ▲] (Photo) for originals containing photographs.

## Sending a fax using automatic dialing

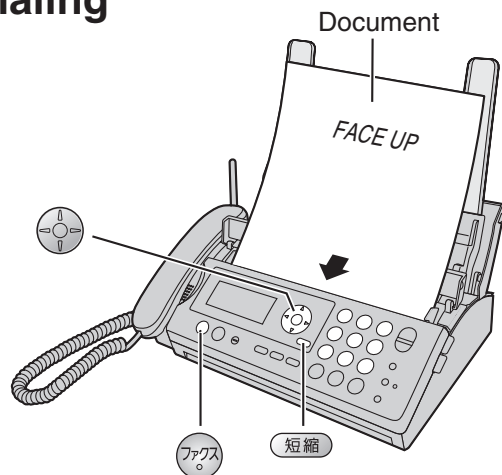

### Using the phonebook

- 1 Insert the document (up to 5 pages) FACE UP until a single beep is heard.
- 2 Press (Phonebook).
- 3 Press (Search button) repeatedly until the desired name is displayed.
- 4 Press (Fax).
  - The unit will start fax transmission.

### Using the speed dialer

- 1 Insert the document (up to 5 pages) FACE UP until a single beep is heard.
- 2 Press (Speed dialer).
- 3 Press the memory station number (① to ⑨).
- 4 Press (Fax).
  - The unit will start fax transmission.



# Receiving faxes

## Receiving a fax manually (AUTO ANSWER off)

Using the main unit:

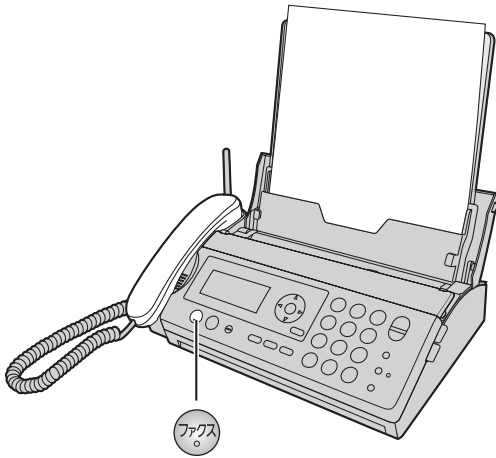

**1** When you hear a ring, lift the handset to answer the call.

**2** When:  
– document reception is required,  
– a fax calling tone (slow beep) is heard, or  
– no sound is heard,  
press **ファクス** (Fax), then replace the handset.

- The unit will start fax reception.

Using the portable handset (KX-FKN512):

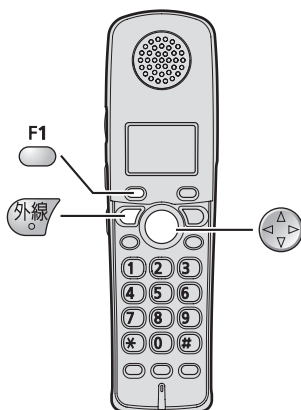

**1** When you hear a ring, lift the portable handset from the charger to answer the call.

- If the portable handset is not set on the charger, press **外線** (Talk).

**2** When:  
– document reception is required,  
– a fax calling tone (slow beep) is heard, or  
– no sound is heard,  
press **F1**.

**3** Press **Search** (Search button) repeatedly until the “ファクス受信” is displayed.

**4** Press **F1** 2 times.  
• The main unit will start fax reception.

## Receiving a fax automatically (AUTO ANSWER on)

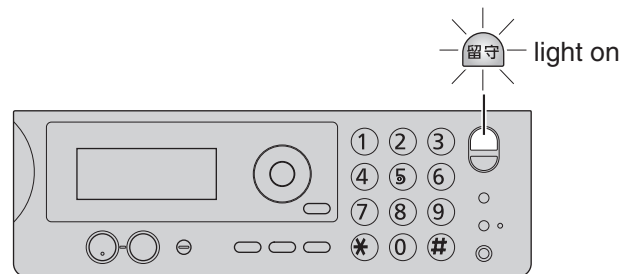

**1** If the **留守** (Auto answer) light is off, turn it on by pressing **留守**.

**2** When receiving a call, the unit will receive a fax document or record a voice message automatically depending on the caller's request.

# Operating the built-in answering device

## Recording your own greeting message

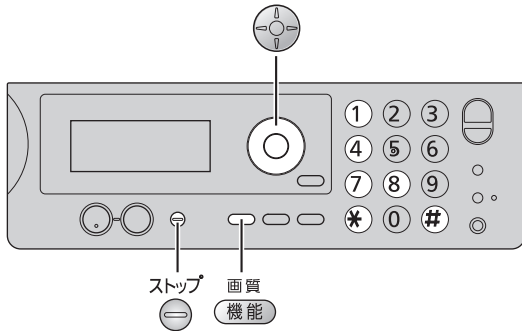

You can record your own greeting message. When receiving a call, it will be played to callers instead of the pre-recorded Japanese greeting message.

- 1 Press **画質機能** (Resolution/Function).
- 2 Press **# 1 4 7**.  

ジ サク オウトウ ロクオン  
[ケツテイ]オス
- 3 Press **決定** (Set).
- 4 Lift the handset.
- 5 Press **決定** (Set) and speak your greeting message after a beep, up to 16 seconds, to the handset.
- 6 Press **ストップ** (Stop) and replace the handset.
  - Your greeting message will be played back automatically.

## Erasing your own greeting message

- 1 Press **画質機能** (Resolution/Function).
- 2 Press **# 1 4 8**.  

ジ サク オウトウ ショウキョ  
[ケツテイ]オス
- 3 Press **決定** (Set).
- 4 Press **\***.
  - The pre-recorded Japanese greeting message will be played when you receive a call.

## Activating the answering device

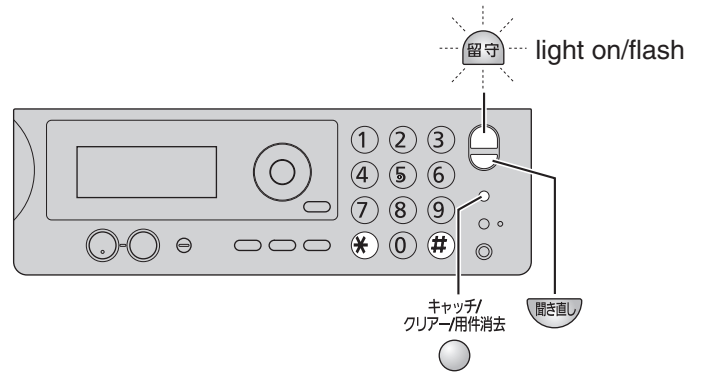

- 1 Turn the **留守** (Auto answer) light on by pressing **留守**.
- 2 When receiving a call, a greeting message will be played and the unit will record a voice message.
  - To record your own greeting message, see left.

## Listening to recorded messages

When new messages are recorded, the **留守** (Auto answer) light will flash.

Press **留守** to listen to recorded messages.

After the messages are played back, the following will be displayed.

- To erase the messages, press **\***. サイセイシタヨクオンショウキョ  
スル=\* シナイ=#
- To save the messages, press **#**.

## Listening to all of the recorded messages

Press **聞き直し** (Replay).

After the messages are played back, the following will be displayed.

- To erase the messages, press **\***. スハテ ショウキョシマスカ?  
ハイ=\* イイエ=#
- To save the messages, press **#**.

## Erasing a specific message

Press **キャッチ/クリアー/用件消去** (Flash/Clear/Eraser) while listening to the message you want to erase, then press **\***.

## Erasing all of the recorded messages

- 1 Press **キャッチ/クリアー/用件消去** (Flash/Clear/Eraser).

スハテ ショウキョシマスカ?  
ハイ=\* イイエ=#

- 2 Press **\***.

## Operating the built-in answering device

### Operating the answering device from a remote location

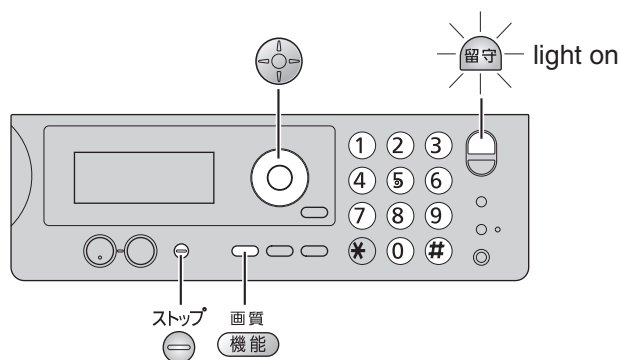

#### Preparation: Programming the remote operation ID

1. Press **画質機能** (Resolution/Function).
2. Press **# 0 0 6**.
3. Enter any 4-digit number (remote operation ID) except \* or #.

**Example :** アソショウ No.=1234  
[4ケタ,ケツテイ]オス

4. Press **決定** (Set).
5. Press **ストップ** (Stop).

#### Operation: Listening to a recorded message from a remote location

Turn the **留守** (Auto answer) light on before you go out. Remote operations are available only from a touch tone telephone.

1. Call your unit.
2. Enter the remote operation ID during the greeting message.
3. Press **2** or wait 4 seconds.
  - Only the new recorded messages will be played back.
  - To listen to all the recorded messages, press **4** after the new messages have been played back.

## Night mode

### Turn on the night mode

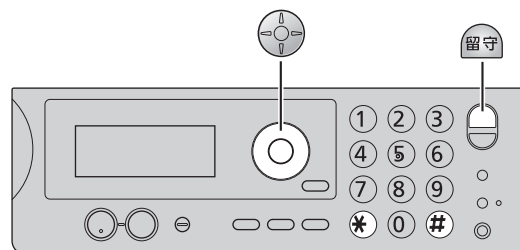

Press **\*** (Night mode) for about 3 seconds.

- “\*\*” is displayed and **留守** lights on.
- When a call is received during night mode, the unit will handle the call silently, either by storing the received fax into memory or by recording the caller's message.
- Night mode allows you to select a block of time during which the unit will not ring for outside calls or make sounds when you change the settings. This feature is useful when you do not want to be disturbed, for example, while sleeping.

### Listening to recorded messages

When new messages are recorded, the **留守** (Auto answer) light will flash.

Press **留守** to listen to recorded messages.

After the messages are played back, the following will be displayed.

- To erase the messages, press **\***. サイセイシタヨウケンシヨウキヨ  
スル=\* シナイ=#
- To save the messages, press **#**.

### Printing received fax documents

When new faxes are received, the following will be displayed.

ファクスガ トトイテイマス  
インサツ ハ [ケツテイ]オス

Press **決定** (Set) 2 times to print fax documents.

### Turn off the night mode

Press **\*** (Night mode) for about 3 seconds.

# Call block

## Blocking the incoming calls

Using the main unit:

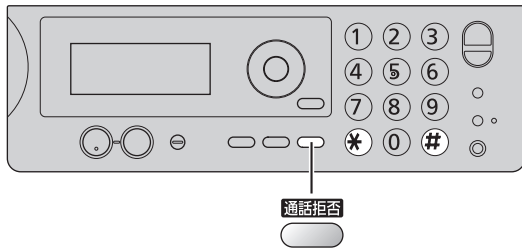

### To block a call using a message

While the unit is ringing, press **通話拒否** (Block).

OR

While you are on an incoming call, press **通話拒否** (Block), then press **\***.

- The unit announces a message to the caller 2 times, then hangs up automatically. The message is announced in Japanese and means "We're sorry, but your call cannot be connected."

### To block a call using chimes

**1** While you are on an incoming call, press **通話拒否** (Block).

**2** Press **#**.

- Chimes from the speaker are heard by the caller.

**3** Explain to the caller that a visitor came and hang up.

### For Number Display service subscribers

If you subscribe to Number Display service, the message heard by the caller will change according to the caller's situation.

#### Example :

If the caller requested not to send caller's information, the message heard by the caller will change to mean "Your phone number is blocked by service provider. Please call again with adding '186' to the beginning of the phone number."

When the following is displayed after pressing

**通話拒否** (Block), you can set the unit to block the call from the same telephone number.

■ To block the call, press **\***.

メイワク セツテイ シマスカ?  
ハイ= \* イイエ=#

■ To cancel blocking, press **#**.

● When the following is displayed, press **#** to cancel.

キョヒ セツテイ シマスカ?  
ハイ= \* イイエ=#

Using the portable handset (KX-FKN512):

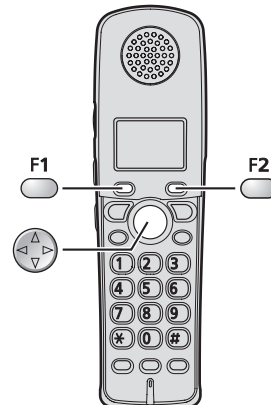

**1** Press **F1** while the unit is ringing or while you are on an incoming call.

**2** Press **Search** (Search button) repeatedly until the "通話拒否" is displayed.

**3** Press **F1** 2 times.

- The unit announces a message to the caller 2 times, then hangs up automatically. The message is announced in Japanese and means "We're sorry, but your call cannot be connected."

### For Number Display service subscribers

If you subscribe to Number Display service, the message heard by the caller will change according to the caller's situation.

#### Example :

If the caller requested not to send caller's information, the message heard by the caller will change to mean "Your phone number is blocked by service provider. Please call again with adding '186' to the beginning of the phone number."

When the following is displayed after operating step 1 to 3, you can set the unit to block the call from the same telephone number.

■ To block the call, press **F1**.

■ To cancel blocking, press **F2**.

迷惑設定  
しますか?

● When the following is displayed, press **F2** to cancel.

拒否設定  
しますか?

# Adjusting the volume of a TV (KX-FKN512)

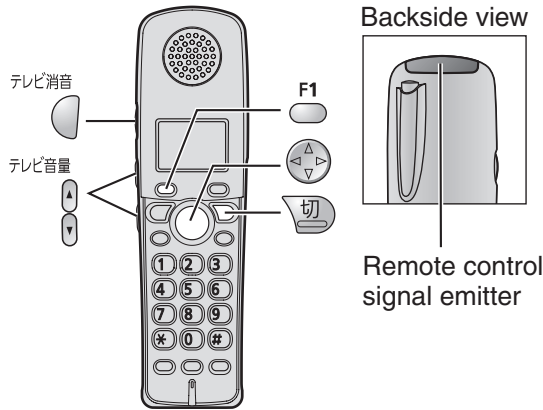

## Preparation: Programming the maker of your TV

1. Press .
2. Press (Search button) repeatedly until the “テレビメーカー登録” is displayed.
3. Press 2 times.
4. Press (Search button) repeatedly until the maker of your TV is displayed.
  - If you do not want to use this feature, please select “使用しない”.
5. Press .
6. Press (Off).

### ● You can select from the following:

松下1	松下2	松下3	三洋1	三洋2
シャープ1	シャープ2	シャープ3	富士通セネラル	ソニー
東芝	NEC1	NEC2	パナソニック	日立1
日立2	パイ	ビクター	三菱1	三菱2
アイワ	使用しない			

- This feature may not work with some TV models even if you select the maker correctly.
- This feature cannot be used with TV/VCR combo decks or PCs with built-in TV tuners.
- Some makers have multiple setting choices (for example, “松下1” to “松下3”). Please choose one which you can operate correctly.

## Operation: Adjusting the TV volume

テレビ音量

Press (TV volume) to adjust the TV volume.

## Operation: Mute the TV volume

テレビ消音

Press (TV mute) to mute TV volume.

- To cancel mute, press (TV mute) again.

# Specifications

KX-PW777E3	Main unit	Portable handset (KX-FKN512)	Battery charger
<b>Power supply</b>	AC 100 V (50 Hz/60 Hz)	Ni-MH battery (Part no. KX-FAN50) DC 3.6 V, 600 mAh	AC adaptor (Part no. PFAP1009) AC 100 V (50 Hz/60 Hz) DC 7.5 V, 100 mA
<b>Power consumption</b>	Transmission: Approx. 10 W Reception: Approx. 16 W Copy: Approx. 18 W Stand by: Approx. 0.8 W (When the F-net service is not in use.) Maximum(*1): Approx. 130 W	/	<ul style="list-style-type: none"> <li>• Charging: Approx. 1.5 W</li> <li>• Stand by: Approx. 0.5 W</li> </ul>
<b>Dimensions (H x W x D)</b>	Approx. 86 X 296 X 181 mm (without handset, projections) Approx. 265 X 296 X 221 mm (recording paper tray opened, without handset, projections)	Approx. 171 X 48 X 38 mm	Approx. 65 X 86 X 96 mm
<b>Mass (Weight)</b>	Approx. 2.3 kg (10 m ink film installed)	Approx. 160 g (battery installed)	Approx. 75 g
<b>Operating environment</b>	5 °C – 35 °C, 45 % – 85 % RH (Relative Humidity)		

KX-PW777E3	Main unit
<b>Applicable line</b>	Public Switch Telephone Network (Tone/Pulse), F-Net, NCC Lines
<b>DC resistance</b>	275 Ω
<b>Compatibility</b>	G3 compatible
<b>Document size</b>	A4–A5 (Max. 210 mm in width, Max. 600 mm in length)
<b>Effective scanning size</b>	208 mm (A4)
<b>Effective printing size</b>	202 mm (A4 size plain paper)
<b>Transmission time</b>	Approx. 15 s/page (Original mode) (*2)
<b>Modem speed</b>	9,600 / 7,200 / 4,800 / 2,400 bps; Automatic fallback
<b>Halftone level</b>	64-level
<b>Scanning density</b>	Horizontal: 8 pels/mm Vertical : 7.7 lines/mm (Fine/Photo), 3.85 lines/mm (Standard)
<b>Scanner type</b>	Contact image sensor
<b>Printer type</b>	Thermal transfer printing on plain paper
<b>Data compression system</b>	Modified Huffman (MH), Original mode
<b>Recording paper size</b>	A4: 210 mm x 297 mm (Plain paper)
<b>Answering device</b>	Greeting message: Digital recording system (up to 16 sec) Pre-recording greeting message ICM Recording: Digital recording system (Approx. 18 min. in total) (*3)
<b>Memory capacity</b>	Max. Approx. 46 pages (Only receiving fax etc.) (*4) Max. Approx. 18 min. (Only recording message) (*3)

\*1 When copying a 100 % black document.

\*2 Transmission speed is based on an A4-size document of 700 characters sent in standard resolution at 9,600 bps. The actual transmission speed depends upon the contents of the page, resolution, telephone line conditions and capability of the other party's machine.

\*3 If there is a silent pause, the total recording time will be longer.

\*4 The memory capacity is based on an A4-size document of 700 characters.







