

Facsimile

Quick Reference Guide

Model No. **KX-PW90CL**



Thank you for purchasing a Panasonic facsimile.

Table of Contents

Finding the controls	2
Installations and connections	4
Setting the date and time	7
Setting your facsimile telephone number	7
Setting your logo	8
Character input and command key table	9
Automatic dialing on the main unit.....	10
Automatic dialing on the portable handset	11
Intercom between the main unit and portable handset	12
Sending faxes	13
Receiving faxes	14
Operating the built-in answering device	16
Individual e-mail services	18
Specifications.....	Back cover

- This guide explains some basic features and operations, but not all of them. For further details, see the Japanese operating instructions.
- This product is designed for use in Japan. Panasonic cannot provide service for this product if used outside Japan.
- Any details given in this guide are subject to change without notice.

Finding the controls

Main unit (control panel)

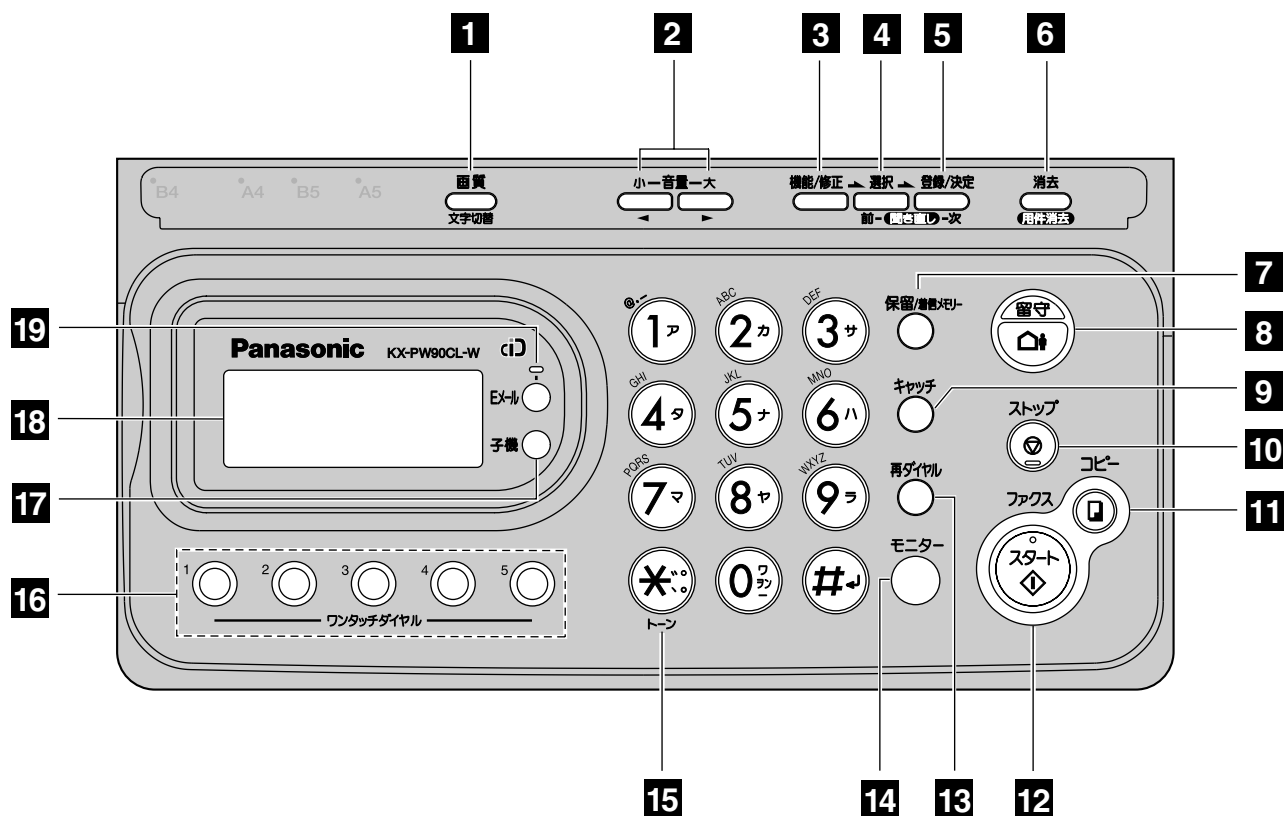

1 Resolution button selects the resolution when faxing or copying.

Character Input Mode button

2 Volume buttons adjust ringer, speaker and handset volume by pressing the up and down buttons.

3 Function button initiates programming.
Edit button

4 Select button selects feature settings.

Previous Replay button

—plays back recorded messages.
—returns to the previous message while listening to a recorded message.

5 Register/Set button stores a parameter.

Next Replay button

—plays back recorded messages.
—skips to the next message while listening to a recorded message.

6 Erase button

7 Hold button

Call Memory button starts a search in the Number Display log.

(For caller ID display service users.)

8 Auto Answer button & indicator

—light on: answering device activated.

—light off: used as a regular telephone.

9 Flash button

(For call waiting service users.)

10 Stop button

11 Copy button starts copying.

12 Start/Fax button starts faxing.

13 Redial button

Pause button

14 Monitor button

15 Tone button switches to tone dialing.

16 One-touch Dial button

17 Portable Handset button

18 Liquid crystal display

19 E-Mail button & indicator

Finding the controls

Portable handset



How to use  **key**

 電話帳 To use the phonebook.

 再ダイヤル To redial the last number dialed.
To insert a pause.

 音量 To adjust the volume.

 外線 To make/answer calls.

 文字切替
 内線 To page the main unit.
To change the character input mode.

 切 To end a call.
To end or exit from editing or other operations.

 保留 To put a call on hold.
To start a search in the Number Display log.
(For caller ID display service users.)

 音量 To adjust the volume.

 クリアー
キャッチ To clear letters/numbers.
For call waiting service users.

 ファクス To receive faxes.

 スピーカーホン To use the speakerphone.

 増設 Used when installing additional portable handsets.

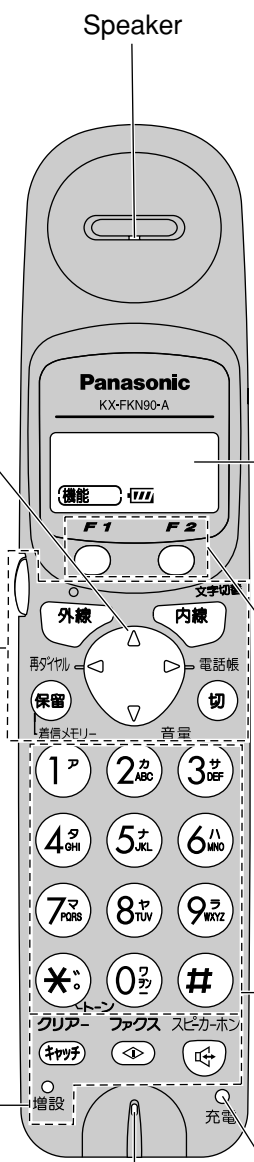



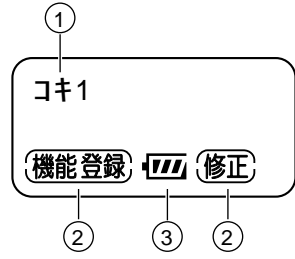

LCD (with back light)

Displays battery strength, telephone numbers etc.





① Portable handset number
② Function menu that is controlled by F1 or F2.
③ Battery strength

How to use   **buttons**

 and  buttons refer to the function displayed on the bottom of the display. They function differently depending on the mode.

Dial buttons

 トーン Tone button
To switch to Tone dialing mode.

 Sharp button

Charge indicator

Charging Red
Full Off

Installations and connections

Installing the ink film

- 1 Open the control panel.

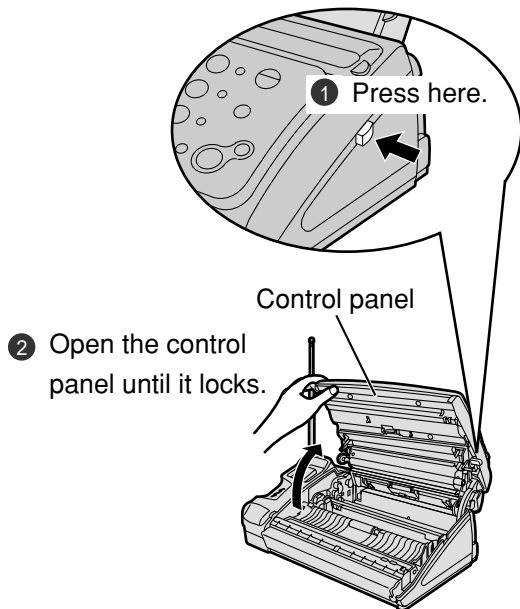

- 2 Insert the ink film.

- 1 Find the "T" shaped gear (blue).

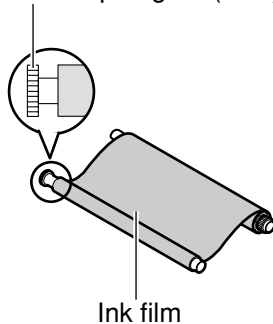

- 2 Insert the blue core into the right slot of the main unit.

- 3 Insert the "T" shaped gear (blue) into the left slot of the main unit.

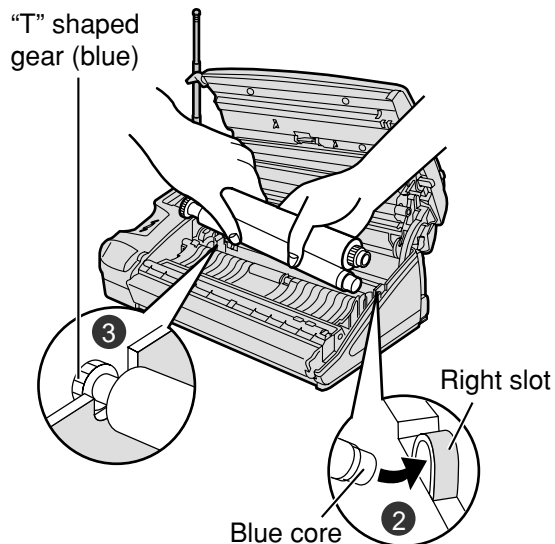

- 4 Insert the white core into the slots shown in the picture below.

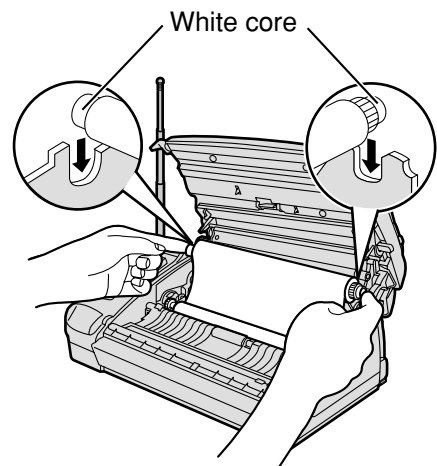

- 5 If the ink film is slack, tighten it by winding the "T" shaped gear.

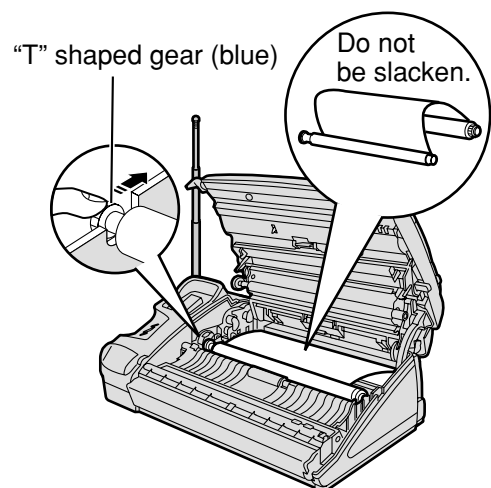

- 3 Close the control panel until it locks.

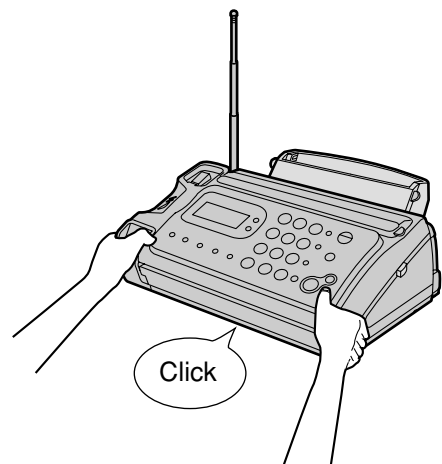

Installations and connections

Installing recording paper (A4 size)

1 Install the recording paper tray.

- 1 Insert the left tab on the recording paper tray into the left slot of the main unit.
- 2 Insert the right tab into the right slot of the main unit.

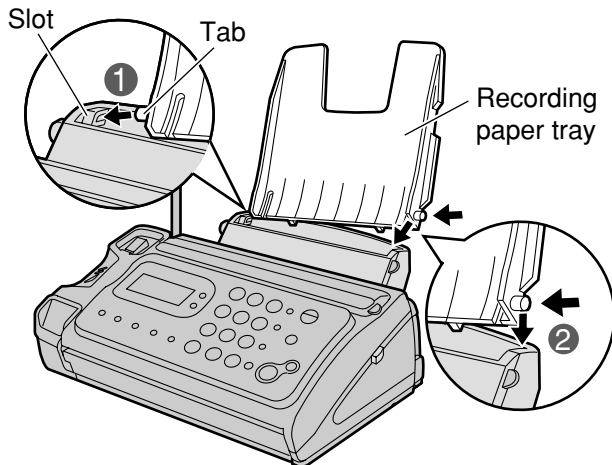

2 Insert the recording paper into the recording paper tray.

- 1 Open the paper entrance cover until it locks.

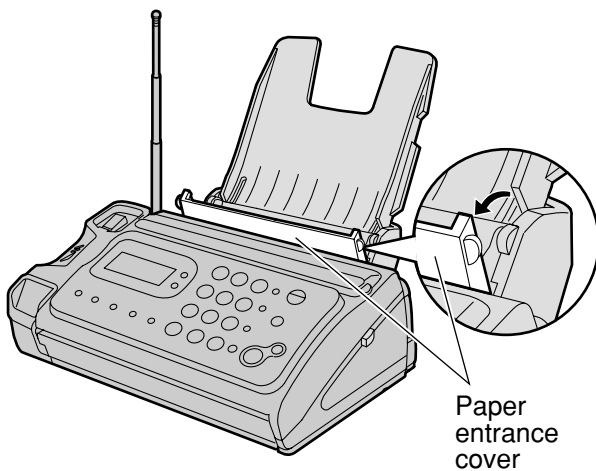

- 2 Fan the stack of recording paper (A4 size).

- 3 Insert the recording paper into the recording paper tray. (Up to 30 sheets)

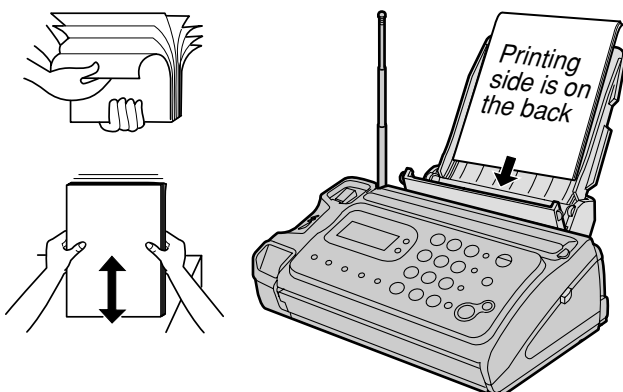

3 Close the paper entrance cover by leaning it back.

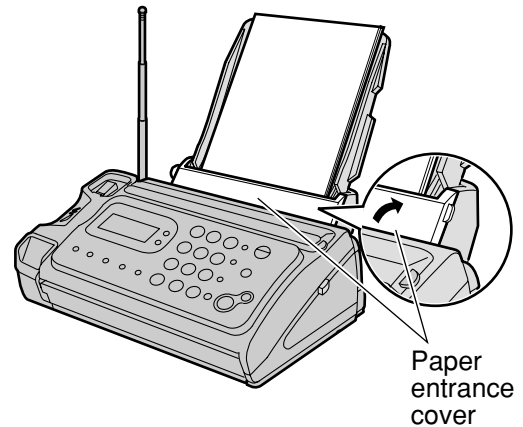

4 Install the recording paper cover on the recording paper tray by sliding it down from the top.

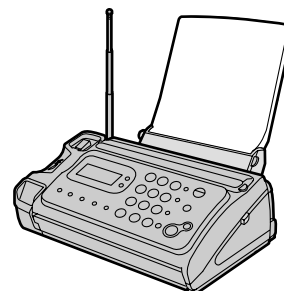
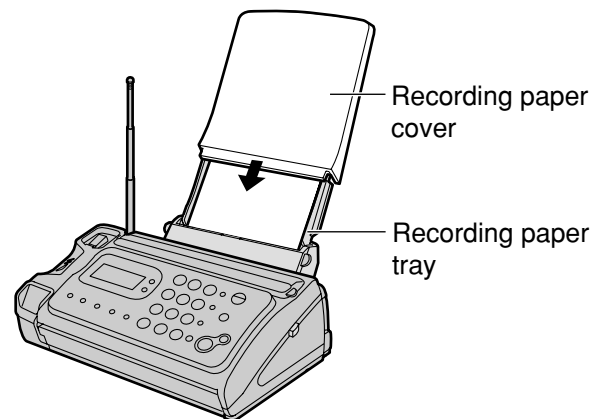

Installations and connections

Setting up the portable handset

1

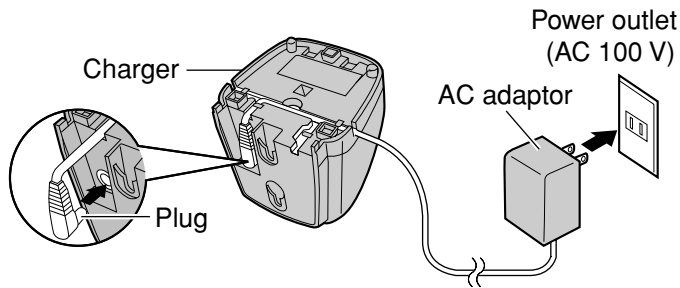

2

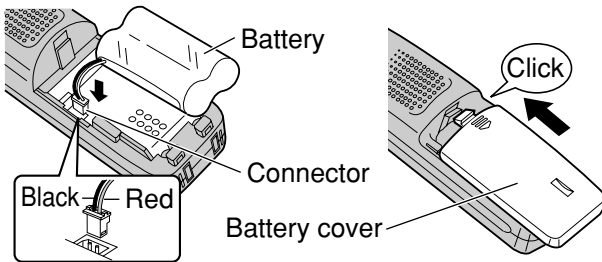

3 Charge the battery in the charger for 10 hours.

Charge indicator 
-lights red:
while charging.
-lights off:
charging completed.

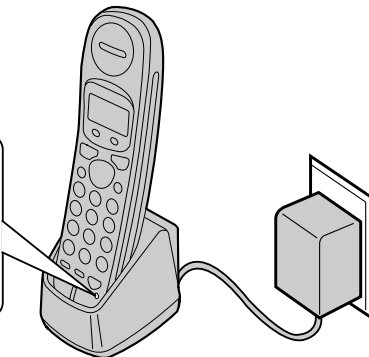

- After your Panasonic battery is fully charged, it will last up to about 7 hours of conversation.

Connecting the main unit

1

Raise the antenna.

2

Connect the cord and place the handset on the main unit.

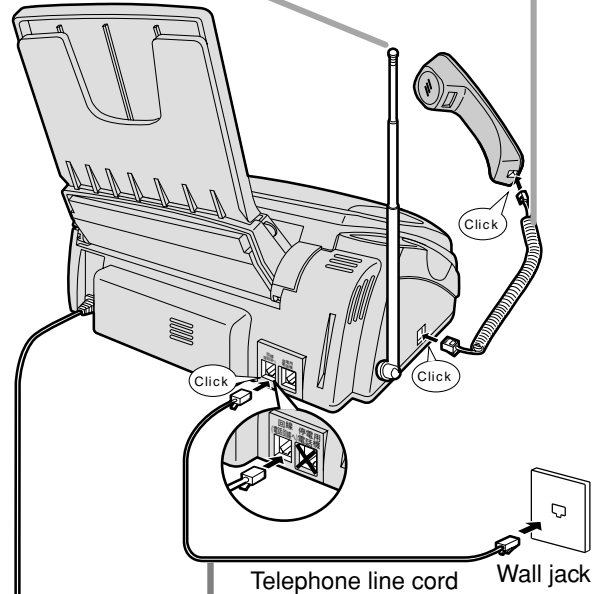

3

Connect the telephone line cord (Supplied accessory).

4

Connect the power cord.

After the Power On...

This unit will automatically select the dialing mode (Tone/Pulse).

Setting the date and time

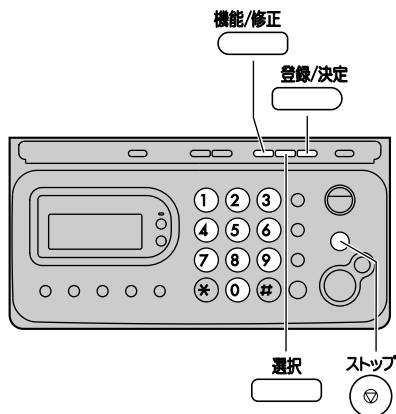

1 Open the document cover and press **機能/修正** (Function/Edit).

キノウ トウロク モード
[センタク] オス

2 Press **選択** (Select).

サイショノ セツテイ
[ケツテイ] オス

3 Press **登録/決定** (Register/Set).

Example :

2002年06月01日
20:10

Cursor

4 Enter the correct year/month/day.

Example: August 1, 2002

Press 2 0 0 2 0 8 0 1 .

2002年08月01日
20:10

5 Enter the correct hour/minute in a 24-hour clock entry.

Example: 15:45 (3:45 PM)

Press 1 5 4 5 .

2002年08月01日
15:45

6 Press **登録/決定** (Register/Set).

トウロク シマシタ



2002年08月01日
15:45

7 Press **ストップ** (Stop).

Example :

8月 1日 15:45
ヨウケン ロクオン 00ケン

Setting your facsimile telephone number

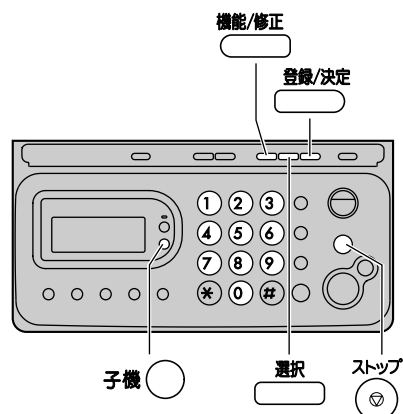

1 Open the document cover and press **機能/修正** (Function/Edit).

キノウ トウロク モード
[センタク] オス

2 Press **選択** (Select).

サイショノ セツテイ
[ケツテイ] オス

3 Press **登録/決定** (Register/Set).

Example :

2002年08月01日
15:45

4 Press **選択** (Select) repeatedly until the following is displayed.

アナタノテノウハノコウ?
TEL=.....

Cursor

5 Enter your facsimile telephone number, up to 20 digits.

Example: 098 765 43 ..

アナタノテノウハノコウ?
TEL=8 765 43 ..

The **子機** (Space) button replaces the digit with a space.

6 Press **登録/決定** (Register/Set).

トウロク シマシタ



アナタノテノウハノコウ?
TEL=098 765 43 ..

7 Press **ストップ** (Stop).

Example :

8月 1日 15:45
ヨウケン ロクオン 00ケン

Setting your logo

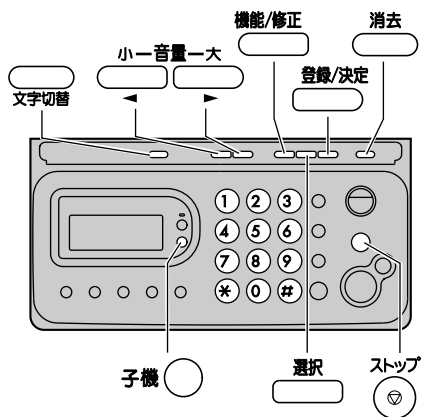

1 Open the document cover and press (Function/Edit).

キノウ トウロク モード
[センタク] オス

2 Press (Select).

サイショノ セッテイ
[ケッテイ] オス

3 Press (Register/Set).

Example : 2002年08月01日
15:45

4 Press (Select).

ナマイ?
Cursor

5 Enter your logo, up to 30 characters, using the dial keypad.

- To enter English characters easily, press (Character input mode) repeatedly and select “英” (English and sign input mode).
- For details, see the table on page 9 for instructions.

Example: Micah

1. Press once.

ナマイ?
M
Cursor

2. Press six times.

ナマイ?
Mi

3. Press six times.

ナマイ?
Mic

4. Press to move the cursor to the next space and press four times.

ナマイ?
Mica

5. Press five times.

ナマイ?
Micah

6 Press (Register/Set).

トウロク シマシタ













ナマイ?
Micah

7 Press (Stop).

Example : 8月 1日 15:45
ヨウケン ロクオン 00ケン

Character input and command key table

Character Dial key	Pressing the dial keys will select a character as shown below.		
	"カナ" Katakana	"英" English	"数" Numbers
①	アイウエオアイウエオ	@ . _ - & \$ ¥ % + = ^ ^	1
②	カキクケコ	A B C a b c	2
③	サシスセソ	D E F d e f	3
④	タチツテトツ	G H I g h i	4
⑤	ナニヌネノ	J K L j k l	5
⑥	ハヒフヘホ	M N O m n o	6
⑦	マミムメモ	P Q R S p q r s	7
⑧	ヤユヨヤユヨ	T U V t u v	8
⑨	ラリルレロ	W X Y Z w x y z	9
⑩	ワヲンー!? ()	! ? / - * # , ; : . ' " () [] { } 「 」	0
✳	ゝ っ っ っ っ	ゝ っ っ っ っ	
Command keys	 (Main unit),  (Portable handset)		Used to change the character input mode.
	 (Main unit),  (Portable handset)		Used to move the cursor to the left and right.
	 (Main unit),  (Portable handset)		Used to delete a character.
	 (Main unit),  (Portable handset)		Used to insert a space.

- When entering e-mail address, the small letters are displayed before the capital letters.
- When entering e-mail address, you can not enter the following symbols: 
- When entering e-mail address, you can enter only English and Numbers.
- When entering e-mail message, pressing  enables you to begin the new line. (“↵” is displayed.)
- The display items of the main unit are somewhat different from that of the portable handset.

Automatic dialing on the main unit

Storing telephone numbers in the one-touch dial

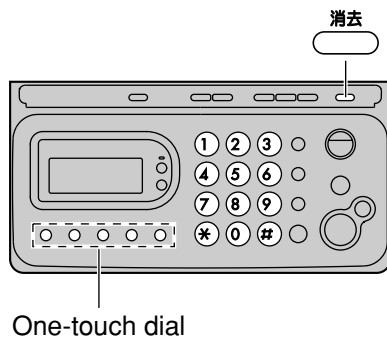

- 1 Press one-touch dial (1 to 5).
Example: one-touch dial 1
Press 1.
- 2 Enter the telephone number, up to 30 digits.
 - To correct a mistake, press **消去** (Clear).
- 3 Press one-touch dial (1 to 5).
Example: one-touch dial 1
Press 1.

Making a voice call using the one-touch dial

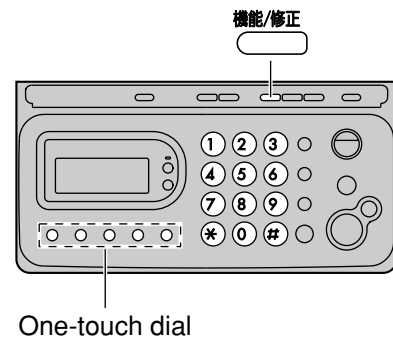

- 1 Press one-touch dial (1 to 5).
- 2 Lift the handset.

Editing a stored number

- 1 Press one-touch dial (1 to 5).
Example: one-touch dial 1
Press 1.
- 2 Press **機能/修正** (Function/Edit).
- 3 Edit the telephone number.
- 4 Press one-touch dial (1 to 5).
Example: one-touch dial 1
Press 1.

Automatic dialing on the portable handset

Storing names and telephone numbers in the phonebook

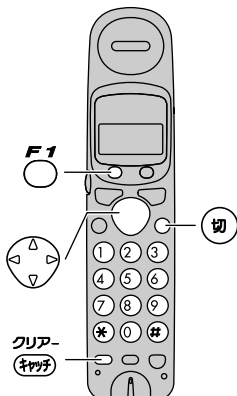

1 Press (Phonebook).

テ	ン	ワ	チ	ヨ	ウ	ケン	サク
ナ	マ	?					[カナ]



ケン	サク	ハ	
[]	オ

2 Press (Register).

- “XXX” shows the remaining station numbers you can store.
- You can program up to 100 stations, including 4 pre-programmed stations.

テ	ン	ワ	チ	ヨ	ウ	ト	ウ	ロ	ク
ア	キ	x	x	x	ケ	ン			



ナ	マ	?					[カナ]
---	---	---	--	--	--	--	------

3 Enter the name, up to 12 characters (see the table on page 9 for instructions).

4 Press (Register).

5 Enter the telephone number, up to 30 digits.

- To correct a mistake, press (Clear).

6 Press (Register).

- To program other items, repeat steps 3 to 6.

7 Press (Off) to exit the program.

Making a voice call using the phonebook

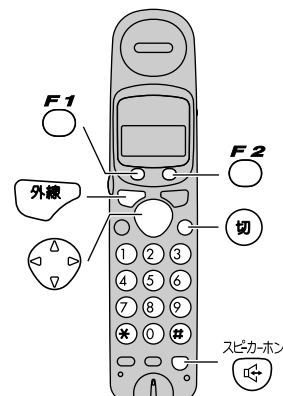

1 Press (Phonebook).

2 Press (Search button) repeatedly until the desired name is displayed.

3 Press (Talk) or press (Speakerphone).

Editing a stored name or number

1 Press (Phonebook).

2 Press (Search button) repeatedly until the desired name is displayed.

3 Press (Edit).

4 Press .

5 Edit the name (see the table on page 9 for instructions).

- If you do not need to edit the name, skip to step 6.

6 Press (Register).

7 Enter the correct telephone number.

- If you do not need to edit the telephone number, skip to step 8.

8 Press (Register).

Intercom between the main unit and portable handset

An intercom is available between the main unit and portable handset.

Using the main unit:

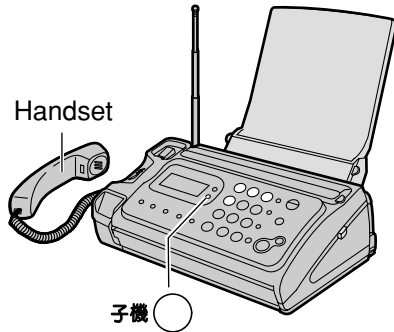

1 ■ For single portable handset users

- ① Lift the handset.

ハンコウ?

- ② Press 子機 (Portable handset).

コキ1 ヨビタシ チユ

■ For multiple portable handset users

- ① Lift the handset, then press 子機 (Portable handset).

- ② Press the portable handset number (① to ④) which you want to call.

- 2 Start talking after the unit sounds "Pi peep" and shows the following.

コキ1 ナイセンツウワ チユ

- 3 Replace the handset.

Using the portable handset:

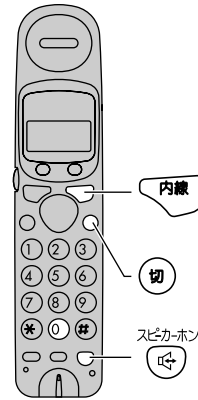

1 ■ For single portable handset users

- Press 内線 (Intercom).

ナイセン ヨビタシ

■ For multiple portable handset users

- Press 内線 (Intercom), then press ①.

- 2 Start talking after the unit sounds "Pi peep" and shows the following.

- You can switch to the speakerphone by pressing

ナイセンツウワ チユ



- スピーカーホン (Speakerphone).

- 3 Press 切 (Off) to end the intercom call.

Sending faxes

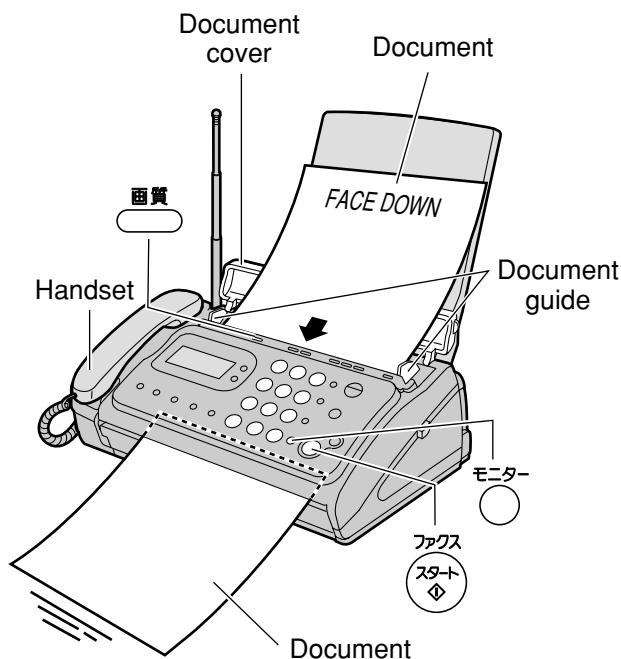



Sending a fax manually

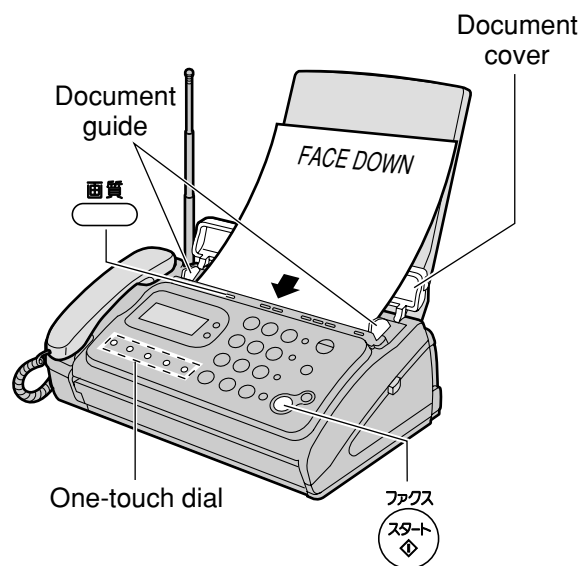

- 1 Open the document cover, and adjust the width of the document guides to the size of the document.
- 2 Insert the document (up to 5 pages) FACE DOWN until a single beep is heard.
- 3 If necessary, press  (Resolution) repeatedly to select the desired setting (see below).
- 4 Lift the handset or press  (Monitor).
- 5 Dial the fax number.
- 6 When a fax tone is heard, press  (Fax).
- 7 Replace the handset if you are using it.
 - The unit will start fax transmission.

Sending a fax using the one-touch dial



- 1 Open the document cover, and adjust the width of the document guides to the size of the document.
- 2 Insert the document (up to 5 pages) FACE DOWN until a single beep is heard.
- 3 If necessary, press  (Resolution) repeatedly to select the desired setting (see below).
- 4 Press one-touch dial ( to ).
- 5 Press  (Fax).
 - The unit will start fax transmission.

To select the resolution

Select the desired resolution according to the type of document, by pressing  (Resolution).

カ シツ=フツウ (Standard) for printed or typewritten originals with normal-sized characters.

カ シツ=チイサイ (Fine) for originals with minute printing.

カ シツ=シャシン (Photo) for originals containing photographs.

Receiving faxes

Receiving a fax manually (AUTO ANSWER off)

Using the main unit:

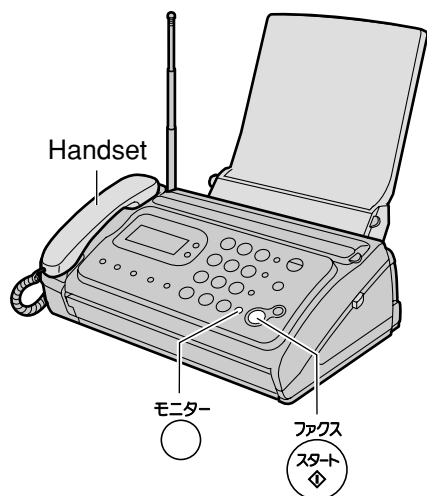

1 When you hear a ring, lift the handset or press ^{モニター} (Monitor) to answer the call.

2 When:
– document reception is required,
– a fax calling tone (slow beep) is heard, or
– no sound is heard,
press ^{ファクス} (Fax).

3 Replace the handset if you are using it.
• The unit will start fax reception.

Using the portable handset:

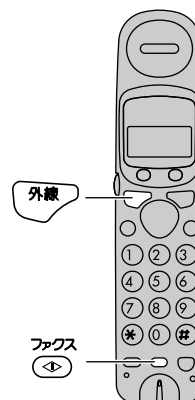



1 When you hear a ring, lift the portable handset from the charger to answer the call.
• If the portable handset is not set on the charger, press ^{外線} (Talk).

2 When:
–document reception is required,
–a fax calling tone (slow beep) is heard, or
–no sound is heard,
press ^{ファクス} (Fax reception).
• The main unit will start fax reception.

Receiving faxes

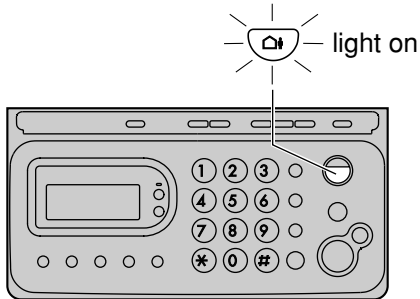
Receiving a fax automatically (AUTO ANSWER on)





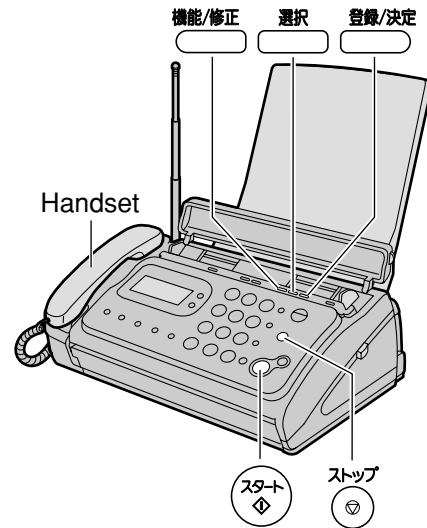

- 1 If the  (Auto answer) light is off, turn it on by pressing .
- 2 When receiving a call, the unit will receive a fax document or record a voice message automatically depending on the caller's request.



Recording your own greeting message



You can record your own greeting message. When receiving a call, it will be played to callers instead of the pre-recorded Japanese greeting message.

- 1 Press  (Function/Edit).
- 2 Press  (Select) repeatedly until the following is displayed.

ルスハ^ンテ^ンソワ^ノセッテイ
[ケッテイ]オス
- 3 Press  (Register/Set).
- 4 Press  (Select) repeatedly until the following is displayed.

シ^ンサク オウトウ ロクオン
[ケッテイ]オス
- 5 Press  (Register/Set).
- 6 Lift the handset.
- 7 Press  (Start) and record your greeting message, up to 16 seconds, using the handset.
- 8 Press  (Stop).
- 9 Replace the handset.
 - Your greeting message will be played back automatically.

Operating the built-in answering device

Activating the answering device

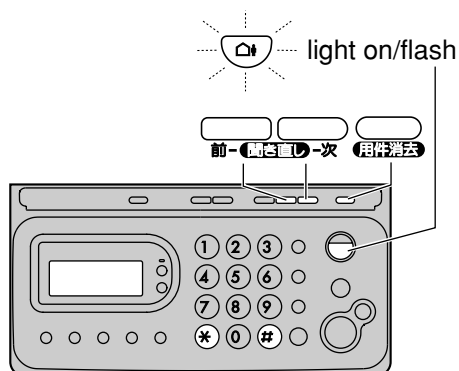

- 1 Turn the (Auto answer) light on by pressing .
- 2 When receiving a call, a greeting message will be played and the unit will record a voice message.
 - To record your own greeting message, see page 15.

Listening to recorded messages

When new messages are recorded, the (Auto answer) light will flash.

Press to listen to recorded messages.

After the messages are played back, the following will be displayed.

- To erase the messages, push . サイセイシタヨウケンショウキヨ
スル = * シナイ = #
- To save the messages, push .

Listening to all of the recorded messages

Press or (Replay).

After the messages are played back, the following will be displayed.

- To erase the messages, push . サイセイシタヨウケンショウキヨ
スル = * シナイ = #
- To save the messages, push .

Erasing a specific message

Press (Erase) while listening to the message you want to erase, then press .

Erasing all of the recorded messages

- 1 Press (Erase).

スハ`テ ショウキヨシマスカ?
ハイ = * イイエ = #

- 2 Press .

Erasing your own greeting message

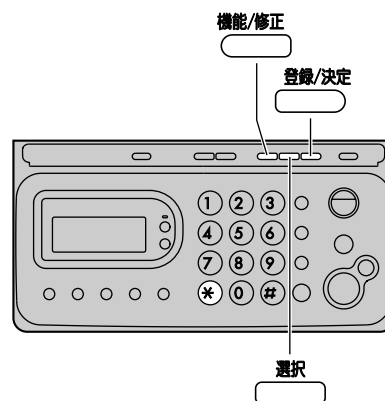

- 1 Press (Function/Edit).
- 2 Press (Select) repeatedly until the following is displayed.

ルスハ`ンテ`ソウノ セッテイ
[ケッテイ] オス

- 3 Press (Register/Set).

- 4 Press (Select) repeatedly until the following is displayed.

シ`サク オウトウ ショウキヨ
[ケッテイ] オス

- 5 Press (Register/Set).



- 6 Press .



- The pre-recorded Japanese greeting message will be played when you receive a call.

Operating the built-in answering device

Operating the answering device from a remote location



Preparation: Programming the remote operation ID

1. Press  (Function/Edit).
2. Press  (Select) repeatedly until the following is displayed.

ルスハ*ンテ*ンワノ セッテイ
[ケッテイ]オス
3. Press  (Register/Set).
4. Enter any 4-digit number (remote operation ID) except * or #.
5. Press  (Register/Set).
6. Press  (Stop).

Operation: Listening to a recorded message from a remote location

Turn the  (Auto answer) light on before you go out. Remote operations are available only from a touch tone telephone.

1. Call your unit.
2. Enter the remote operation ID during the greeting message.
3. Press  or wait 4 seconds.
 - Only the new recorded messages will be played back.
 - To listen to all the recorded messages, press  after the new messages have been played back.

Individual e-mail services

Using the e-mail services

Kyushu Matsushita Electric Co., Ltd. (hereafter called "KME") offers individual information services, such as e-mail.

Your fax machine with e-mail features will enable you to send an e-mail to another party's personal computer (PC) or another e-mail fax machine anywhere in the world through the Internet. Also, you will be able to receive an e-mail from them.

To access the Internet using your fax machine,

- you need a credit card (VISA, JCB or MASTER as of August 2002) and
- have to subscribe to individual information services offered by KME beforehand.

The application fee including call charges will be charged to your Credit Card.

Important:

- If your fax machine is connected to a home telephone system or a private branch exchange (PBX) system, these services are not available.

Application fee and call charges

KME information services	Registration fee	¥500
	Information Service fee (Call charge included)	¥20/minute (8 am-11 pm) ¥18.5/minute (11 pm-8 am)

- As of August 2002.
- Tax not included.

KME information services

The following services are available with your fax machine. The information service fee including the call charge will be applied.

- E-mail reception and printing (page 20)
- Text e-mail sending (page 21)
- Fax e-mail sending (page 22)
- Storing one-touch address (free of charge) (page 23)
- Others

Note:

- KME plans to add new information services and the information service fee is subject to change. KME will announce them by e-mail to its customers.
- For the PC user to view your fax e-mail sent from your fax machine, the following PC software will be required.
 - E-mail software that can read the MIME format
 - TIFF viewer software
- A functional setup of fax can be performed with a PC. (charge)

Please contact our web address:

http://www.kme.panasonic.co.jp/its/otx_e/netde/

Individual e-mail services

Subscribing to KME information services

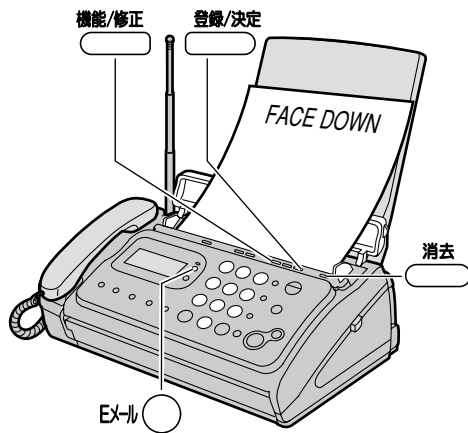

1 Fill in the included application form.

2 Press **機能/修正** (Function/Edit), then press **Eメール** (E-mail).

3 Press **登録/決定** (Register/Set).

4 Enter your 16-digit credit card number.

- To correct a mistake, press **消去** (Clear).

5 Press **登録/決定** (Register/Set).

6 Enter your credit card number again, then press **登録/決定** (Register/Set).

7 Enter the valid date of your credit card.

8 Press **登録/決定** (Register/Set).

9 Insert the application form FACE DOWN.

10 Press **登録/決定** (Register/Set).

- The unit will start fax transmission.

11 After approx. 5 minutes, the unit will ring, and a data communication will start automatically between your unit and KME.

- If you answer this call, hang up and wait for a while until the communication is completed.

12 When the communication is completed, a user registration form will be printed.

- Please save the address and ID code for future reference.

13 Press **Eメール** (E-mail).

14 Press **登録/決定** (Register/Set).

- An information service guide will be printed.

Individual e-mail services

Receiving and printing an e-mail

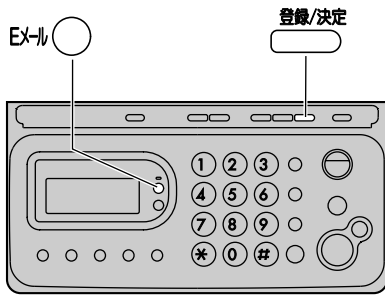

1 Press Eメール (E-mail) .

2 Press 登録/決定 (Register/Set).

- If there is an e-mail you have not viewed yet, the unit will print the received e-mail.
- If there is no e-mail, the following will be displayed.

ミシ ュンEメール 0ケン

The file formats recognized by your fax machine are:

- JPEG • ~. doc
- TIFF • ~. xls
- BMP • ~. ppt
- TXT • ~. pdf

(as of August 2002)

Individual e-mail services

Sending a text e-mail from the main unit

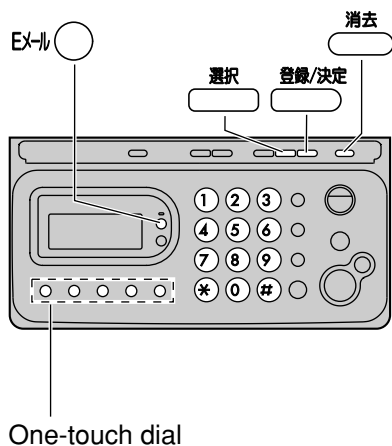

1 Press **Eメール** (E-mail).

2 Press **選択** (Select).

モシ⁺ Eメール ソリューション
[ケッテイ] オス

3 Press **登録/決定** (Register/Set).

4 Enter the desired e-mail address (see the table on page 9 for instructions).

- You can select the desired address using the one-touch dial.

1. Press one-touch dial (¹○ to ⁵○).

2. Press **登録/決定** (Register/Set).

To store an address, see page 23.

5 Press **登録/決定** (Register/Set).

- The display will show the last title you entered.

To delete this title, press **消去** (Clear) for 2 or more seconds.

6 Enter the title of your e-mail, up to 32 characters (see the table on page 9 for instructions).

7 Press **登録/決定** (Register/Set).

- The display will show the last message you entered.

To delete this message, press **消去** (Clear) for 2 or more seconds.

8 Enter your e-mail message, up to 200 characters (see the table on page 9 for instructions).

9 Press **登録/決定** (Register/Set).

Individual e-mail services

Sending a fax e-mail

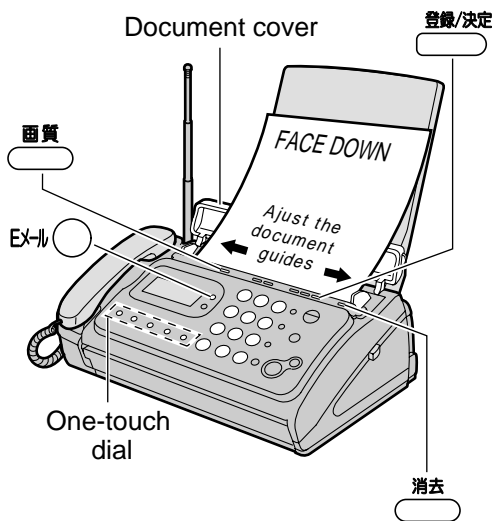

- 1** Open the document cover, and adjust the width of the document guides to the size of the document.
- 2** Insert the document (up to 5 pages) FACE DOWN until a single beep is heard.
- 3** If necessary, press (Resolution) repeatedly to select the desired setting (see page 13).
- 4** Press (E-mail), then press (Register/Set).
- 5** Enter the desired e-mail address (see the table on page 9 for instructions).
 - You can select the desired address using the one-touch dial.
 - 1. Press one-touch dial (¹○ to ⁵○).
 - 2. Press (Register/Set).To store an address, see page 23.
- 6** Press (Register/Set).
 - The display will show the last title you entered.
 - To delete this title, press (Clear) for 2 or more seconds.
- 7** Enter the title of your fax e-mail, up to 32 characters (see the table on page 9 for instructions).
- 8** Press (Register/Set).

Individual e-mail services

Storing e-mail address in the one-touch dial

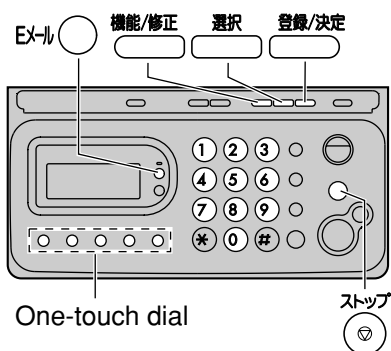

- 1 Press **機能/修正** (Function/Edit), then press **EX-ML** (E-mail).
- 2 Press **選択** (Select).

ワンタッチ アドレス [ケッテイ] オス

- 3 Press **登録/決定** (Register/Set).

ワンタッチタ イヤルヲ オンテ クタ サイ

- 4 Press one-touch dial (1 to 5).
Example: one-touch dial 2
Press 2.
• You can program up to 5 stations, including 1 pre-programmed stations.
- 5 Enter the e-mail address, up to 60 characters (see the table on page 9 for instructions).
- 6 Press one-touch dial (1 to 5).
Example: one-touch dial 2
Press 2.
- 7 Press **ストップ** (Stop) to exit the program.

Editing a stored e-mail address

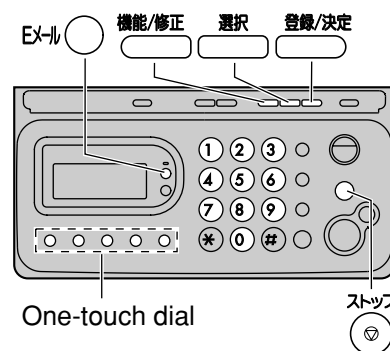

- 1 Press **機能/修正** (Function/Edit), then press **EX-ML** (E-mail).
- 2 Press **選択** (Select).
- 3 Press **登録/決定** (Register/Set).
- 4 Press one-touch dial (1 to 5).
Example: one-touch dial 2
Press 2.
- 5 Press **機能/修正** (Function/Edit).
- 6 Edit the e-mail address (see the table on page 9 for instructions).
- 7 Press one-touch dial (1 to 5).
Example: one-touch dial 2
Press 2.
- 8 Press **ストップ** (Stop) to exit the program.

Specifications

KX-PW90CL	Main unit	Portable handset	Battery charger
Power supply	AC 100 V (50 Hz/60 Hz)	Ni-Cd battery (Part no. KX-FAN37) DC 2.4 V, 600 mAh	AC adaptor (Part no. PFAP1009) AC 100 V (50 Hz/60 Hz) DC 7.5 V, 100 mA
Power consumption	Transmission: Approx. 16 W Reception: Approx. 20 W Copy: Approx. 20 W Stand by: Approx. 0.7 W Maximum(*1): Approx. 125 W		• Charging: Approx. 1.1 W • Stand by: Approx. 0.4 W
Dimensions (H x W x D)	Approx. 139 X 344 X 250 mm (without projections) Approx. 378 X 344 X 298 mm (recording paper tray installed, without projections)	Approx. 181 X 44 X 40 mm	Approx. 72 X 72 X 90 mm
Mass (Weight)	Approx. 3.7 kg (10 m ink film installed)	Approx. 170 g (battery installed)	Approx. 77 g
Operating environment	5 °C – 35 °C, 45 % – 85 % RH (Relative Humidity)		

KX-PW90CL	Main unit
Applicable line	Public Switch Telephone Network (Tone/Pulse), F-Net, NCC Lines
DC resistance	320 Ω (*2)
Compatibility	G3 compatible
Document size	B4-A5(Max.257 mm in width, Max. 800 mm in length)
Effective scanning size	252 mm (B4) 208 mm (A4)
Effective printing size	202 mm (A4 size plain paper)
Transmission time	Approx. 15 s/page (Original mode) (*3)
Modem speed	9,600 / 7,200 / 4,800 / 2,400 bps; Automatic fallback
Halftone level	64-level
Scanning density	Horizontal: 8 pels/mm Vertical: 7.7 lines/mm (Fine/Photo), 3.85 lines/mm (Standard)
Scanner type	Contact image sensor
Printer type	Thermal transfer printing on plain paper
Data compression system	Modified Huffman (MH), Original mode
Recording paper size	A4: 210 mm x 297 mm (Plain paper)
Answering device	Greeting message: Digital recording system (up to 16 sec) Pre-recording greeting message ICM Recording: Digital recording system (Approx. 18 min. in total) (*4)
Memory capacity	Max. Approx. 46 pages (Only receiving fax etc.) (*5) Max. Approx. 18 min. (Only Recording message) (*4)

*1 When copying a 100% black document.

*2 If you cannot make a call due to DC resistance, consult your dealer.

*3 Transmission speed is based on an A4-size document of 700 characters sent in standard resolution at 9,600 bps. The actual transmission speed depends upon the contents of the page, resolution, telephone line conditions and capability of the other party's machine.

*4 If there is a silent pause, the total recording time will be longer.

*5 The memory capacity is based on an A4-size document of 700 characters.